

VOLVO PENTA INDUSTRIAL DIESEL

TAD732GE

179 kW (243 hp) at 1500 rpm, 197 kW (268 hp) at 1800 rpm

The TAD732GE is a powerful, reliable and economical Generating Set Diesel Engine built on the dependable in-line six design.

Durability & low noise

Designed for easiest, fastest and most economical installation. Well-balanced to produce smooth and vibration-free operation with low noise level.

To maintain a controlled working temperature in cylinders and combustion chambers, the engine is equipped with piston cooling. The engine is also fitted with replaceable cylinder liners and valve seats/guides to ensure maximum durability and service life of the engine.

Low exhaust emission

The state of the art, high-tech injection and charging system with low internal losses contributes to excellent combustion and low fuel consumption.

The TAD732GE complies with EU Stage 2 and TA-Luft exhaust emission regulations.

Easy service & maintenance

Easily accessible service and maintenance points contribute to the ease of service of the engine.

Technical description

Engine and block

- Optimized cast iron cylinder block with optimum distribution of forces
- Piston cooling for low piston temperature and reduced ring temperature
- Drop forged steel connecting rods
- Crankshaft hardened bearing surfaces and fillets for moderate load on main and big-end bearings
- Keystone top compression rings for long service life
- Replaceable valve guides and valve seats
- Three PTO positions at flywheel end
- Lift eyelets
- Flywheel housing with connection acc. to SAE 2
- Flywheel for flexible coupling and friction clutch
- Transport brackets

Lubrication system

- Full flow disposable spin-on oil filter, for extra high filtration
- Rotary displacement oil pump driven by the crankshaft
- Deep centre oil sump, 30° inclination
- Oil filler on top



Features

- Electronic governing, EDC 4
- CAN bus communication
- Compact design
- High power to weight ratio
- Emission compliant
- Noise optimized engine design
- A wide selection of optional equipment and power settings

- Oil dipstick, short in front
- Integrated full flow oil cooler, side-mounted

Fuel system

- Six hole fuel injection nozzles
- Direct injection unit pumps
- Electronic governor with smoke limiter function
- Washable fuel prefilter with water separator
- Rotary low-pressure fuel pump
- Fine fuel filter of disposable type

Intake and exhaust system

- Connection flange for exhaust line
- Turbo charger, centre low with exhaust flange
- Closed crankcase ventilation
- Heater flange in charge air inlet (without power relay)

Cooling system

- Belt driven, maintenance-free coolant pump with high degree of efficiency
- Efficient cooling with accurate coolant con-

trol through a water distribution duct in the cylinder block

- Reliable thermostat with minimum pressure drop
- Cooling water pipe, inlet and outlet
- Belt driven coolant pump, ratio 1.0:1
- Fan hub
- Fan on separate bracket 292mm above crankshaft
- Pusher fan Ø 600 mm

Electrical system

- 24V electrical system
- Alternator 1x35A / 24V, low left
- Starter motor, Melco, 5.5kW / 24V, single pole
- ECU (without high altitude sensor) control and monitoring of oil pressure, coolant temperature, coolant level, charge air pressure, engine rpm and fuel temperature compensation
- Engine wiring

**VOLVO
PENTA**

TAD732GE

Technical Data

General

Engine designation	TAD732GE	
No. of cylinders and configuration	in-line 6	
Method of operation	4-stroke	
Bore, mm (in.)	108 (4.25)	
Stroke, mm (in.)	130 (5.12)	
Displacement, l (in ³)	7.15 (436.3)	
Compression ratio	18:1	
Dry weight, with cooling package, kg (lb)	785 (1731)	
Wet weight, with cooling package, kg (lb)	826 (1821)	

Performance	1500 rpm	1800 rpm
with fan, kW (hp) at:		
Prime Power	160 (218)	176 (240)
Max Standby Power	179 (243)	197 (268)

Lubrication system	1500 rpm	1800 rpm
Oil consumption, liter/h (US gal/h) at:		
Prime Power	0.08 (0.021)	0.09 (0.024)
Max Standby Power	0.09 (0.024)	0.11 (0.029)
Oil system capacity incl filters, liter	34	

Fuel system	1500 rpm	1800 rpm
Specific fuel consumption at:		
Prime Power, g/kWh (lb/hph)		
25 %	270 (0.438)	260 (0.422)
50 %	219 (0.354)	225 (0.364)
75 %	213 (0.345)	217 (0.352)
100 %	213 (0.345)	218 (0.354)
Max Standby Power, g/kWh (lb/hph)		
25 %	234 (0.379)	244 (0.395)
50 %	215 (0.348)	220 (0.356)
75 %	212 (0.344)	216 (0.350)
100 %	214 (0.347)	220 (0.356)

Intake and exhaust system	1500 rpm	1800 rpm
Air consumption at 27°C, m ³ /min (cfm):		
Prime Power	11.4 (403)	14.42 (509)
Max Standby Power	12.4 (438)	14.42 (509)
Max allowable air intake restriction, kPa (In wc)	3.5 (14.1)	3.5 (14.1)
Heat rejection to exhaust, kW (BTU/min) at:		
Prime Power	140 (7945)	161 (9173)
Max Standby Power	156 (8872)	181 (10310)
Exhaust gas temperature after turbine, °C (°F) at:		
Prime Power	529 (984)	495 (923)
Max Standby Power	542 (1008)	515 (959)
Max allowable back-pressure in exhaust line, kPa (In wc)	5 (20.1)	7 (28.1)
Exhaust gas flow, m ³ /min (cfm) at:		
Prime power	31.9 (1125)	38.3 (1353)
Max Standby Power	35.1 (1240)	41.8 (1476)

Cooling system	1500 rpm	1800 rpm
Heat rejection radiation from engine, kW (BTU/min)		
Prime Power	17 (972)	20 (1109)
Max Standby Power	19 (1086)	22 (1245)
Heat rejection to coolant kW (BTU/min)		
Prime Power	70 (3981)	76 (4316)
Max Standby Power	76 (4328)	84 (4749)
Fan power consumption, kW (hp)	4.4 (6)	7.4 (10)

Standard equipment

Engine

- Automatic belt tensioner •
- Lift eyelets •

Flywheel

- Flywheel housing with conn. acc. to SAE 2 •
- Flywheel 10" and 11.5" disc •
- Vibration dampers •

Engine suspension

- Fixed front suspension •

Lubrication system

- Oil dipstick •
- Full-flow oil filter of spin-on type •
- By-pass oil filter of spin-on type •
- Oil cooler, side mounted •
- Low noise oil sump •

Fuel system

- Fuel filters of disposable type •
- Electronic unit injectors •
- Pre-filter with water separator •

Intake and exhaust system

- Air filter with replaceable paper insert •
- Air restriction indicator •
- Air cooled exhaust manifold •
- Connecting flange for exhaust pipe •
- Exhaust flange with v-clamp •
- Turbo charger, low right side •
- Crankcase ventilation, open •
- Cooling system**
- Tropical radiator incl intercooler -1)
- Gear driven coolant pump •
- Fan hub •
- Thrust fan -1)
- Fan guard -1)
- Belt guard -1)

Control system

- Engine Management System (EMS) with CAN-bus interface SAE J1939 and stand alone interface •

Alternator

- Alternator 35A / 24 V •

Starting system

- Starter motor, 5.5kW, 24 V •

Instruments and senders

- Temp.- and oil pressure for automatic stop/alarm 103°C •

Engine Packing

- Plastic wrapping •

1) must be ordered, see order specification
 - optional equipment or not applicable
 • included in standard specification

Dimensions TAD732GE

Not for installation

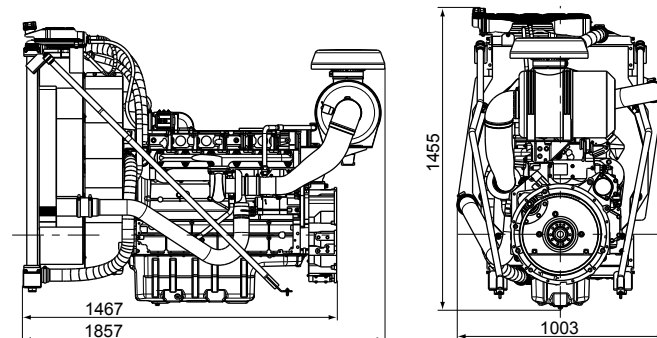

Note! Not all models, standard equipment and accessories are available in all countries. All specifications are subject to change without notice. The engine illustrated may not be entirely identical to production standard engines.

Power Standards

The engine performance corresponds to ISO 3046, BS 5514 and DIN 6271. The technical data applies to an engine without cooling fan and operating on a fuel with calorific value of 42.7 MJ/kg (18360 BTU/lb) and a density of 0.84 kg/liter (7.01 lb/US gal), also where this involves a deviation from the standards. Power output guaranteed within 0 to +2% at rated ambient conditions at delivery. Ratings are based on ISO 8528.

Engine speed governing in accordance with ISO 3046/IV, class A1 and ISO 8528-5 class G3

Exhaust emissions

The engine complies with EU stage 2 and TA-luft exhaust emission regulations.

Rating Guidelines

PRIME POWER rating corresponds to ISO Standard Power for continuous operation. It is applicable for supplying electrical power at variable load for an unlimited number of hours instead of commercially purchased power. A10 % overload capability for governing purpose is available for this rating.

MAXIMUM STANDBY POWER rating corresponds to ISO Standard Fuel Stop Power. It is applicable for supplying standby electrical power at variable load in areas with well established electrical networks in the event of normal utility power failure. No overload capability is available for this rating. 1 hp = 1 kW x 1.36

Information

For more technical data and information, please look in the Generating Set Engines Sales Guide.

VOLVO PENTA

AB Volvo Penta
 SE-405 08 Göteborg, Sweden
 www.volvopenta.com