

**PERKINS GENERATOR  
STANDBY POWER  
58 KVA / 42 KW  
PRIME POWER  
53 KVA / 46 KW  
(UK)**



# 1100 Series 1103A-33TG1 Diesel Engine – Electropak

53.9 kWm / 72.3 hp @ 1800 rpm

Building upon Perkins proven reputation within the power generation industry, the 1100 Series range of Electropak engines now fit even closer to customers needs.

In the world of power generation success is only gained by providing more for less. With the 1103A-33TG1 Perkins has engineered even higher levels of reliability, yet lowered the cost of ownership.

1100A units are designed for territories that do not require compliance to EPA or EU emissions legislation. These units are able to meet TA luft legislation.



Specification		
Number of cylinders	3 vertical in-line	
Bore and stroke	105 x 127 mm	4.1 in x 5 in
Displacement	3.3 litres	201 in <sup>3</sup>
Aspiration	Turbocharged	
Cycle	4 stroke	
Combustion system	Direct injection	
Compression ratio	17.25:1	
Rotation	Anti-clockwise, viewed from flywheel	
Total lubricating capacity	7.9 litres	2.1 US gal
Cooling system	Water-cooled	
Total coolant capacity	10.2 litres	2.7 US gal

[www.perkins.com](http://www.perkins.com)

Photographs are for illustrative purposes only and may not reflect final specification. All information in this document is substantially correct at time of printing and may be altered subsequently. Final weight and dimensions will depend on completed specification.

Publication No. PN1781B/12/14 Produced in England ©2014 Perkins Engines Company Limited

 **Perkins**<sup>®</sup>

THE HEART OF EVERY GREAT MACHINE

# 1100 Series 1103A-33TG1 Diesel Engine – ElectropaK

53.9 kWm / 72.3 hp @ 1800 rpm

## Features and benefits

### Compact, efficient power

- 1100 Series is the result of an intensive period of customer research that has guided the development of the range
- The new 3.3 litre cylinder block ensures bore roundness is maintained under the pressures of operation. It also ensures combustion and mechanical noise is lowered
- A new cylinder head has re-established Perkins mastery of air control

### Quality by design

- Product design and Class A manufacturing improvements enhance product reliability while maintaining Perkins legendary reputation for durability

### Cost effective power

- Compact size and low noise
- Lower fuel consumption and oil use
- 500 hour service intervals
- **Warranties and Service Contracts**

We provide one-year warranties for constant speed engines and two-year warranties for variable speed models, as standard. These are supported by multilevel Extended Service Contracts that can be bought additionally

Discover more: [www.perkins.esc](http://www.perkins.esc)

### Product support

- Perkins actively pursues product support excellence by ensuring our distribution network invest in their territory – strengthening relationships and providing more value to you, our customer
- Through an experienced global network of distributors and dealers, fully trained engine experts deliver total service support around the clock, 365 days a year. They have a comprehensive suite of web based tools at their fingertips covering technical information, parts identification and ordering systems, all dedicated to maximising the productivity of your engine
- Throughout the entire life of a Perkins engine, we provide access to genuine OE specification parts and service. We give 100% reassurance that you receive the very best in terms of quality for lowest possible cost .. wherever your Perkins powered machine is operating in the world
- To find your local distributor: [www.perkins.com/distributor](http://www.perkins.com/distributor)

[www.perkins.com](http://www.perkins.com)

Photographs are for illustrative purposes only and may not reflect final specification.  
All information in this document is substantially correct at time of printing and may be altered subsequently.  
Final weight and dimensions will depend on completed specification.

Publication No. PN1781B/12/14 Produced in England ©2014 Perkins Engines Company Limited

 **Perkins**<sup>®</sup>

THE HEART OF EVERY GREAT MACHINE

# 1100 Series 1103A-33TG1 Diesel Engine – ElectropaK

53.9 kWm / 72.3 hp @ 1800 rpm

## Technical information

### Air inlet

- Mounted air filter

### Fuel system

- Rotary type pump
- Next generation fuel filter

### Lubrication system

- Wet sump with filler and dipstick
- Spin-on oil filter

### Cooling system

- Thermostatically controlled system with gear-driven circulation pump and belt-driven pusher fan
- Mounted radiator and piping

### Electrical equipment

- 12 volt starter motor and 12 volt 65 amp alternator with DC output
- 12 volt shutdown solenoid energised to run

### Flywheel and housing

- High inertia flywheel to SAE J620 Size 10/11½
- SAE 3 flywheel housing

### Mountings

- Front engine mounting bracket

### Literature

- User's Handbook
- Workshop manual (optional)
- Parts book (optional)

### Optional equipment

- Woodward electronic governor (LCG2)

[www.perkins.com](http://www.perkins.com)

Photographs are for illustrative purposes only and may not reflect final specification.  
All information in this document is substantially correct at time of printing and may be altered subsequently.  
Final weight and dimensions will depend on completed specification.

Publication No. PN1781B/12/14 Produced in England ©2014 Perkins Engines Company Limited

 **Perkins**<sup>®</sup>

THE HEART OF EVERY GREAT MACHINE

# 1100 Series 1103A-33TG1 Diesel Engine – Electropak

53.9 kWm / 72.3 hp @ 1800 rpm

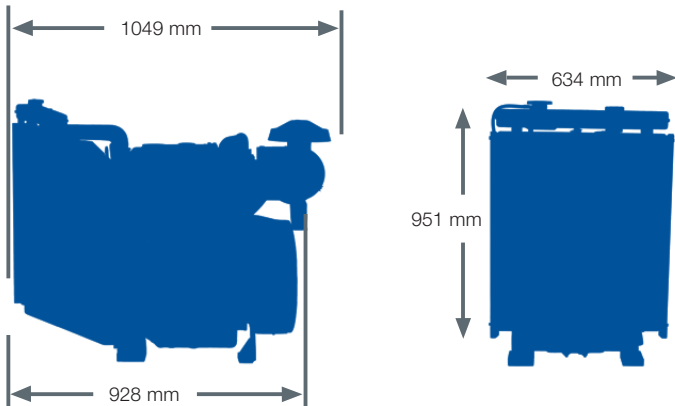

Engine package weights and dimensions

Engine package weights and dimensions		
Length	1049 mm	41.3 in
Width	634 mm	24.9 in
Height	951 mm	37.4 in
Weight (dry)	420 kg	926 lb

[www.perkins.com](http://www.perkins.com)

Photographs are for illustrative purposes only and may not reflect final specification.  
All information in this document is substantially correct at time of printing and may be altered subsequently.  
Final weight and dimensions will depend on completed specification.

Publication No. PN1781B/12/14 Produced in England ©2014 Perkins Engines Company Limited

 **Perkins**<sup>®</sup>

THE HEART OF EVERY GREAT MACHINE

# 1100 Series 1103A-33TG1 Diesel Engine – Electropak

53.9 kWm / 72.3 hp @ 1800 rpm

Speed rpm	Type of operation	Typical generator output (Net)		Engine power			
				Gross		Net	
		kVA	kWe	kWm	hp	kWm	bhp
1800	Prime power	53.1	42.5	50.5	67.7	48.9	65.6
	Standby power	58.7	46.9	55.6	74.6	53.9	72.3

The above ratings represent the engine performance capabilities to conditions specified in ISO 8528/1, ISO 3046/1:1986, BS5514/1. Derating may be required for conditions outside these; consult Perkins Engines Company Limited.

Generator powers are typical and are based on an average alternator efficiency and a power factor (cos.  $\theta$ ) of 0.8 Fuel specification: BS 2869: Part 2 1998 Class A2 or DIN EN 590. Lubricating oil: 15W40 to API CG4.

#### Rating definitions

**Prime power:** Variable load. Unlimited hours usage with an average load factor of 80% of the published prime power over each 24 hour period. A 10% overload is available for 1 hour in every 12 hours of operation. **Standby power:** Variable load. Limited to 500 hours annual usage, up to 300 hours of which may be continuous running. No overload is permitted.

Percent of prime power	Fuel consumption at 1800 rpm	
	UK g/hr	l/hr
Standby power	3.1	14.3
Prime power	2.8	12.9
75%	2.1	9.9
50%	1.5	7.1

[www.perkins.com](http://www.perkins.com)

Photographs are for illustrative purposes only and may not reflect final specification. All information in this document is substantially correct at time of printing and may be altered subsequently. Final weight and dimensions will depend on completed specification.

Publication No. PN1781B/12/14 Produced in England ©2014 Perkins Engines Company Limited



THE HEART OF EVERY GREAT MACHINE



**TAL 042**

## **Low Voltage Alternator - 4 pole**

Three-phase 25 to 60 kVA - 50 Hz / 31.5 to 75 kVA - 60 Hz  
Dedicated single-phase 18 to 42 kVA - 50 Hz / 23 to 53 kVA - 60 Hz  
Electrical and mechanical data

**LEROY-SOMER™**

***Nidec***  
All for dreams

# TAL 042 - Three-phase & Single-phase

## Adapted to needs

The TAL alternator range is designed to meet the needs of general applications such as prime power and stand-by.

## Compliant with international standards

The TAL range complies with international standards and regulations: IEC 60034 and derivative.

The range is designed, manufactured and marketed in an ISO 9001 and 14001 environment.

## Electrical design

- Class H insulation
- Shunt excitation
- Low voltage winding:
  - Three-phase 50 Hz: 380V - 400V - 415V - 440V / 220V - 230V - 240V
  - 60 Hz: 380V - 416V - 440V - 480V / 220V - 208V - 240V
- Single-phase 50 Hz: 115V - 230V
- 60 Hz: 120V - 240V
- 4-terminal plates in 6-wire version
- Optimized performance

## Robust design

- Compact and rugged assembly to withstand engine vibrations
- Steel frame
- Aluminum flanges and shields
- Single bearing design compatible with most diesel engines
- Sealed for life single bearing
- Direction of rotation: clockwise and counterclockwise without derating



## Excitation and regulation system suited to the application

	Excitation system				Regulation options	
	AVR	Shunt	AREP	PMG	UL <sub>c/us</sub>	Remote voltage potentiometer
Three-phase 6-wire	R120	Standard				
	R150	Option				√
	R180		Standard	Standard		√
	R438		Option	Option	√	√
Three-phase 12-wire	R120	Standard				
	R220	Option			√	√
	R180		Standard	Standard		√
	R438		Option	Option	√	√
Single-phase	R121	Standard				√
	R221	Option			√	√

√: Possible option

## Compact terminal box

- Easy access to AVR and terminals

## Environment and protection

- IP Code IP 23
- Standard winding protection for non-harsh environment with relative humidity ≤ 95%

## Available options

- Three-phase 12-wire with 8-terminal plates
- AREP or PMG excitation
- UL<sub>c/us</sub>
- Customized painting (machine not painted as standard)
- Space heaters
- Flying leads
- Dedicated single-phase
- Winding 8 optimized for three-phase 380V / 416V - 60Hz
- Winding protection for harsh environments and relative humidity greater than 95% (system 2 - 4): derating according to the following table

	50 Hz			60 Hz
Type	380 V	400 V	415 V	All voltages
TAL 042	0.97	1 except 0.97 for TAL 042 G & H	1 except 0.97 for TAL 042 G & H	1 except 0.97 for TAL 042 G & H





Efficiencies 400 V - 50 Hz (— P.F.: 0.8) (----- P.F.: 1)

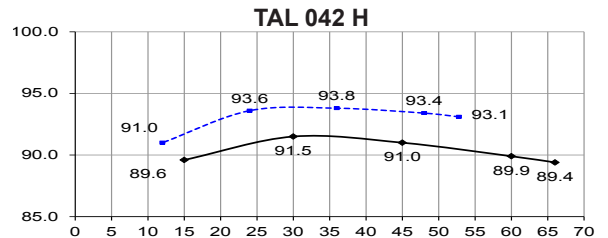
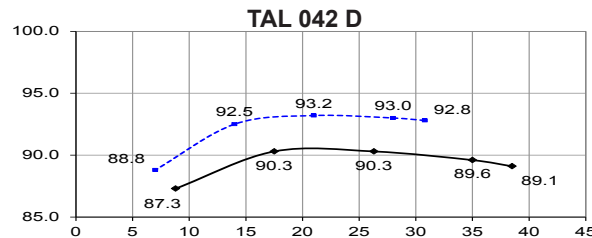
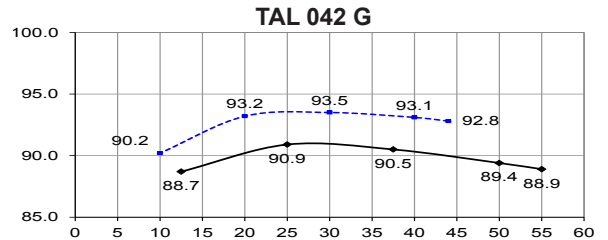
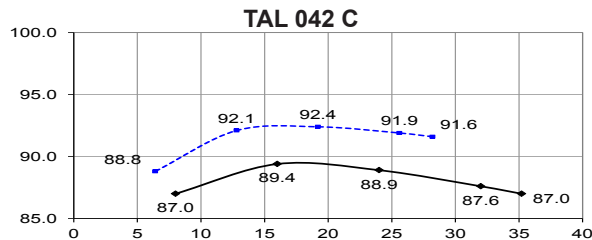
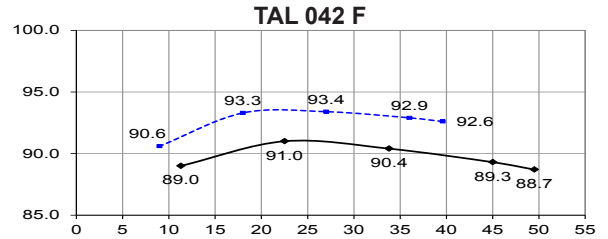
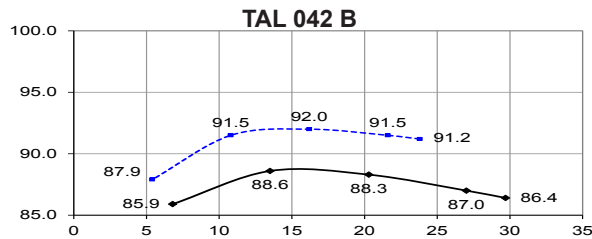
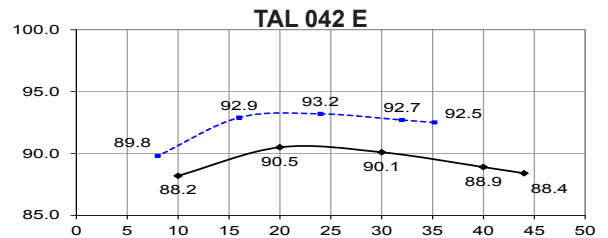
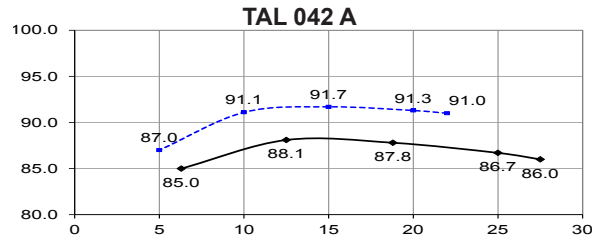

Reactances (%). Time constants (ms) - Class H / 400 V

	A	B	C	D	E	F	G	H
<b>Kcc</b> Short-circuit ratio	0.49	0.46	0.44	0.49	0.42	0.4	0.43	0.4
<b>Xd</b> Direct-axis synchro. reactance unsaturated	257	267	279	246	281	294	283	303
<b>Xq</b> Quadrature-axis synchro. reactance unsaturated	131	136	142	125	143	150	144	154
<b>T'do</b> No-load transient time constant	786	813	861	944	944	980	998	1031
<b>X'd</b> Direct-axis transient reactance saturated	16.3	16.4	16.2	13	14.8	15	14.1	14.7
<b>T'd</b> Short-circuit transient time constant	50	50	50	50	50	50	50	50
<b>X''d</b> Direct-axis subtransient reactance saturated	8.1	8.2	8.1	6.5	7.4	7.5	7	7.3
<b>T''d</b> Subtransient time constant	5	5	5	5	5	5	5	5
<b>X''q</b> Quadrature-axis subtransient reactance saturated	11.5	11.6	11.5	9.2	10.6	10.7	10.1	10.5
<b>Xo</b> Zero sequence reactance	0.68	0.68	0.67	0.54	0.62	0.62	0.59	0.61
<b>X2</b> Negative sequence reactance saturated	9.88	9.91	9.82	7.89	9.02	9.12	8.61	8.93
<b>Ta</b> Armature time constant	8	8	8	8	8	8	8	8

Other class H / 400 V data

<b>io (A)</b> No-load excitation current SHUNT and AREP (*)	0.63	0.6	0.59	0.56	0.56	0.54	0.58	0.50 / 0.74
<b>ic (A)</b> On-load excitation current SHUNT and AREP (*)	2.14	2.13	2.21	1.92	2.19	2.23	2.38	2.11 / 3.24
<b>uc (V)</b> On-load excitation voltage SHUNT and AREP (*)	32.2	32	32.8	28.5	32.1	32.3	33.9	33.5 / 21.4
<b>ms</b> Response time ( $\Delta U = 20\%$ transient)	500	500	500	500	500	500	500	500
<b>kVA (**)</b> Start ( $\Delta U = 20\%$ cont. or $\Delta U = 30\%$ trans.) SHUNT	37.4	40.3	48.2	65.6	65.9	73.4	86.4	99.5
<b>kVA (**)</b> Start ( $\Delta U = 20\%$ cont. or $\Delta U = 30\%$ trans.) AREP	44.7	48.1	58	78.8	78.9	88	103.6	119.2
<b>%</b> Transient $\Delta U$ (on-load 4/4) SHUNT - P.F.: 0.8 <sub>LAG</sub>	20.1	20.1	20	17.5	19	19.1	18.4	18.9
<b>%</b> Transient $\Delta U$ (on-load 4/4) AREP - P.F.: 0.8 <sub>LAG</sub>	18	18	17.9	15.7	17	17.1	16.5	16.9
<b>W</b> No-load losses	739	733	785	888	888	908	1063	1152
<b>W</b> Heat dissipation	3067	3209	3593	3248	3955	4307	4694	5364

(\*) SHUNT / AREP : H - (\*\*) P.F. = 0.6

Transient voltage variation 400V - 50 Hz

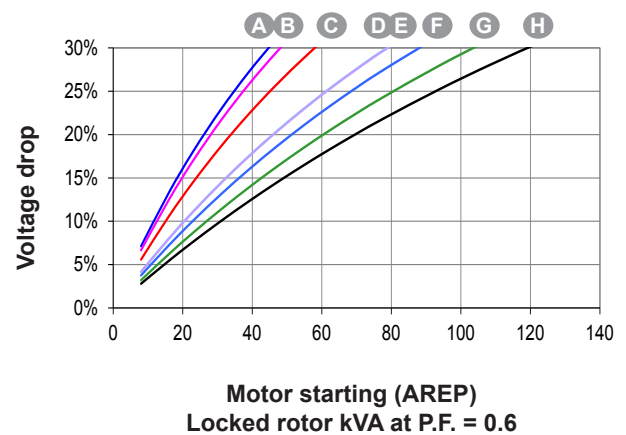
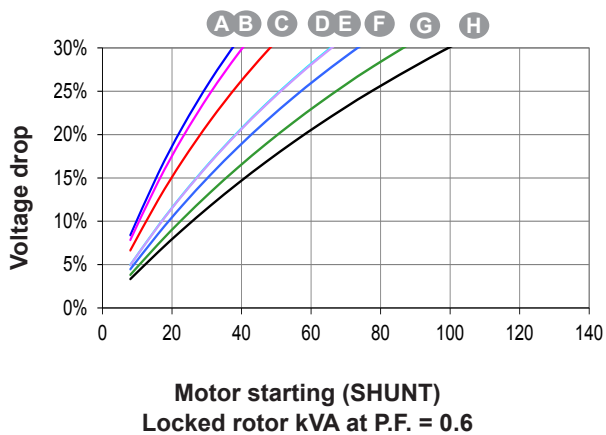
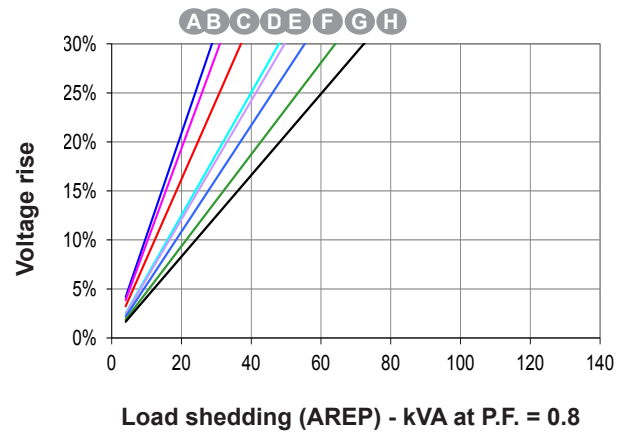
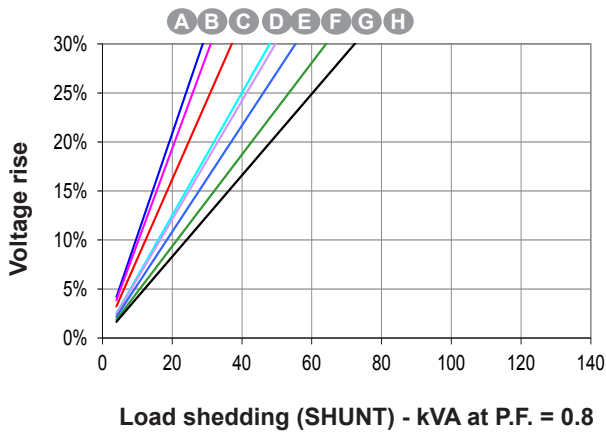
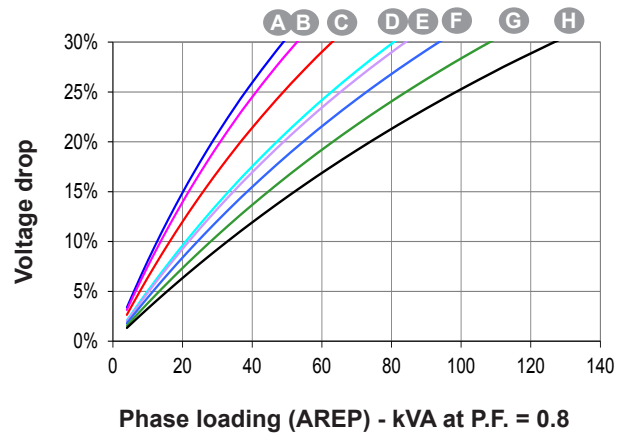
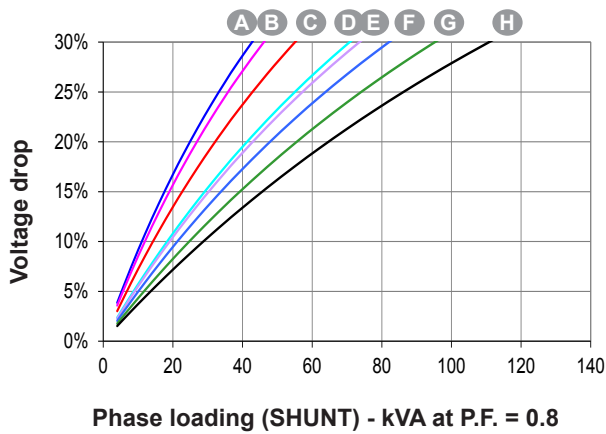

- 1) For a starting P.F. other than 0.6, the starting kVA must be multiplied by  $K = \text{Sine P.F.} / 0.8$
- 2) For voltages other than 400V (Y), 230V ( $\Delta$ ) at 50 Hz, then kVA must be multiplied by  $(400/U)^2$  or  $(230/U)^2$ .

## Efficiencies 480 V - 60 Hz (— P.F.: 0.8) (..... P.F.: 1)

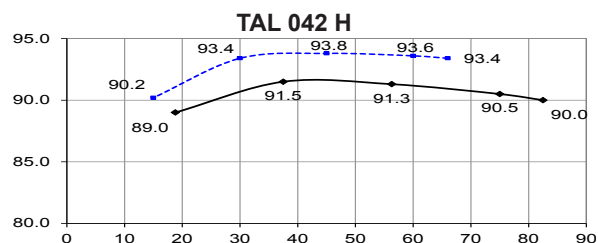
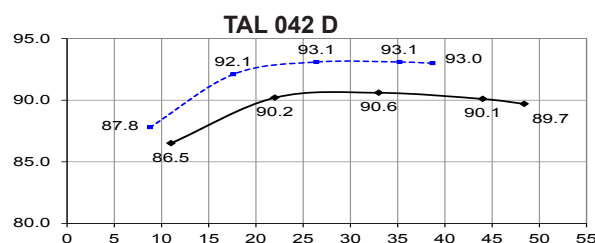
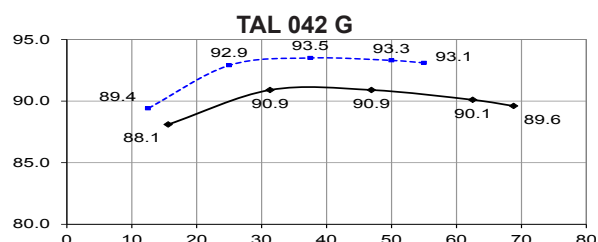
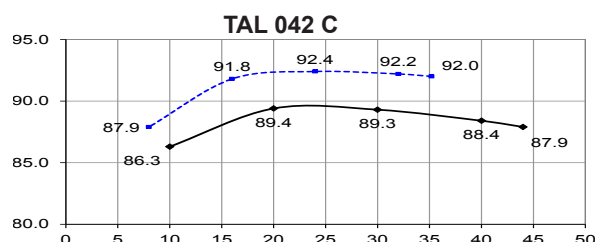
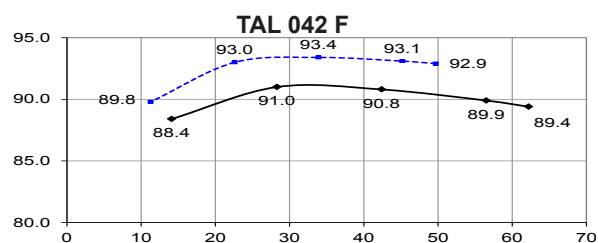
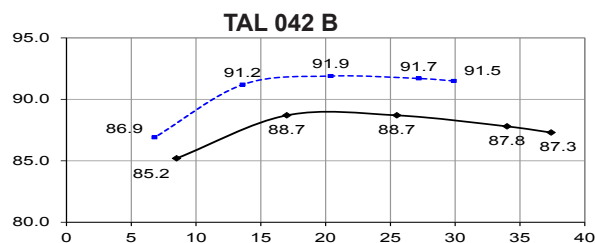
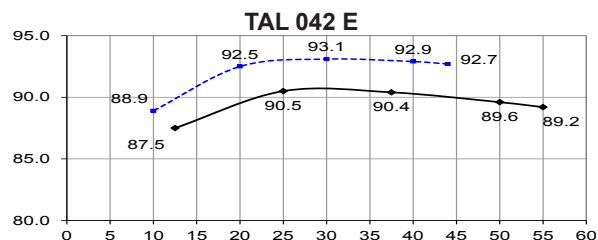
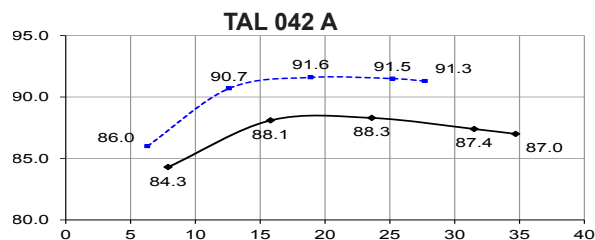

## Reactances (%). Time constants (ms) - Class H / 480 V

	A	B	C	D	E	F	G	H
<b>Kcc</b> Short-circuit ratio	0.47	0.44	0.42	0.46	0.41	0.38	0.41	0.38
<b>Xd</b> Direct-axis synchro. reactance unsaturated	270	280	292	257	292	308	295	316
<b>Xq</b> Quadrature-axis synchro. reactance unsaturated	138	143	148	131	149	157	150	161
<b>T'do</b> No-load transient time constant	786	813	861	944	944	980	998	1031
<b>X'd</b> Direct-axis transient reactance saturated	17.2	17.2	16.9	13.6	15.5	15.7	14.7	15.3
<b>T'd</b> Short-circuit transient time constant	50	50	50	50	50	50	50	50
<b>X''d</b> Direct-axis subtransient reactance saturated	8.6	8.6	8.4	6.8	7.7	7.8	7.3	7.6
<b>T''d</b> Subtransient time constant	5	5	5	5	5	5	5	5
<b>X''q</b> Quadrature-axis subtransient reactance saturated	12.1	12.1	12	9.7	11	11.2	10.5	10.9
<b>Xo</b> Zero sequence reactance	0.71	0.71	0.7	0.56	0.64	0.65	0.61	0.63
<b>X2</b> Negative sequence reactance saturated	10.37	10.4	10.24	8.27	9.39	9.55	8.97	9.3
<b>Ta</b> Armature time constant	8	8	8	8	8	8	8	8

### Other class H / 480 V data

<b>io (A)</b> No-load excitation current SHUNT and AREP (*)	0.63	0.6	0.59	0.56	0.56	0.54	0.58	0.48 / 0.74
<b>ic (A)</b> On-load excitation current SHUNT and AREP (*)	2.16	2.15	2.21	1.92	2.17	2.21	2.32	2.05 / 3.14
<b>uc (V)</b> On-load excitation voltage SHUNT and AREP (*)	32.8	32.6	33.3	29	32.4	32.7	34.1	33.6 / 21.5
<b>ms</b> Response time ( $\Delta U = 20\%$ transient)	500	500	500	500	500	500	500	500
<b>kVA(**)</b> Start ( $\Delta U = 20\%$ cont. or $\Delta U = 30\%$ trans.) SHUNT	44.8	48.4	57.7	78.7	78.9	88.1	103.6	119.2
<b>kVA(**)</b> Start ( $\Delta U = 20\%$ cont. or $\Delta U = 30\%$ trans.) AREP	53.6	57.7	69.4	94.3	94.5	105.4	124.1	142.7
<b>%</b> Transient $\Delta U$ (on-load 4/4) SHUNT - P.F.: 0.8 <sub>LAG</sub>	20.7	20.7	20.5	18	19.4	19.6	18.9	19.3
<b>%</b> Transient $\Delta U$ (on-load 4/4) AREP - P.F.: 0.8 <sub>LAG</sub>	18.5	18.6	18.4	16.2	17.4	17.6	16.9	17.3
<b>W</b> No-load losses	1051	1047	1121	1270	1270	1300	1513	1642
<b>W</b> Heat dissipation	3603	3764	4184	3867	4620	5061	5489	6277

(\*) SHUNT / AREP : H - (\*\*) P.F. = 0.6

Transient voltage variation 480V - 60 Hz

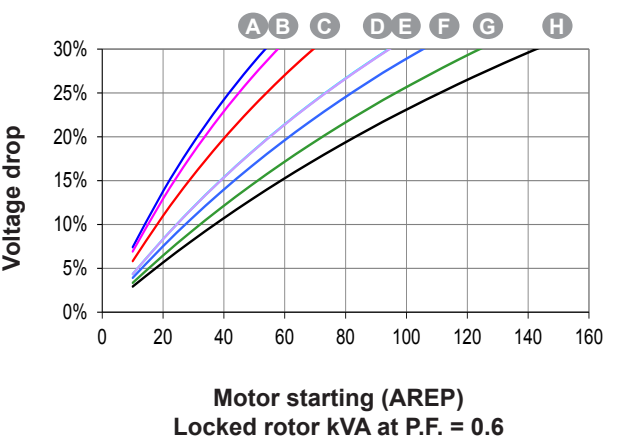
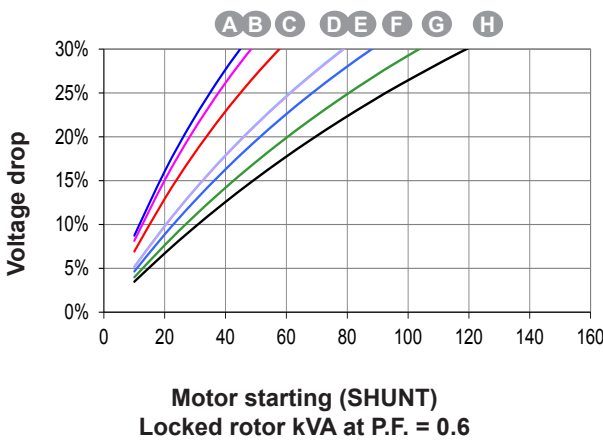
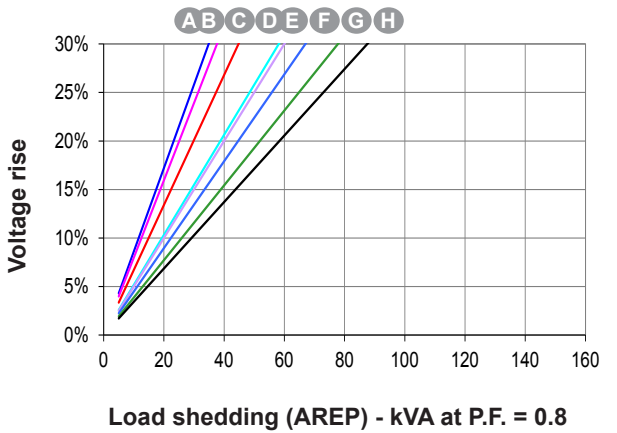
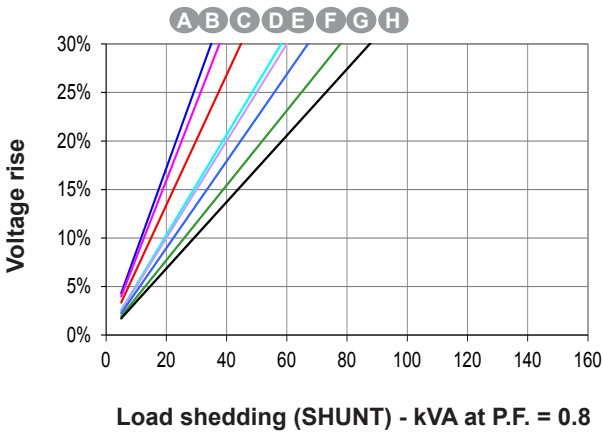
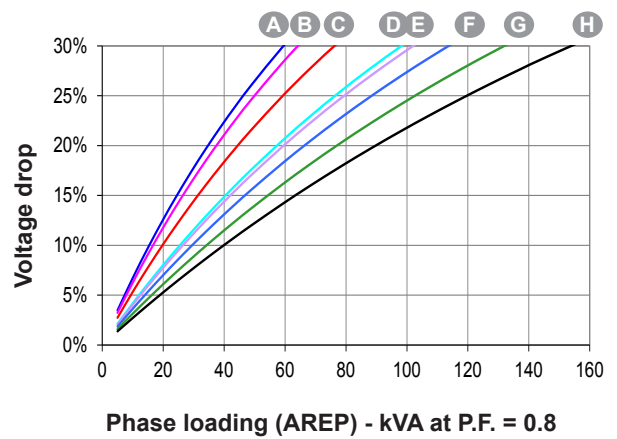
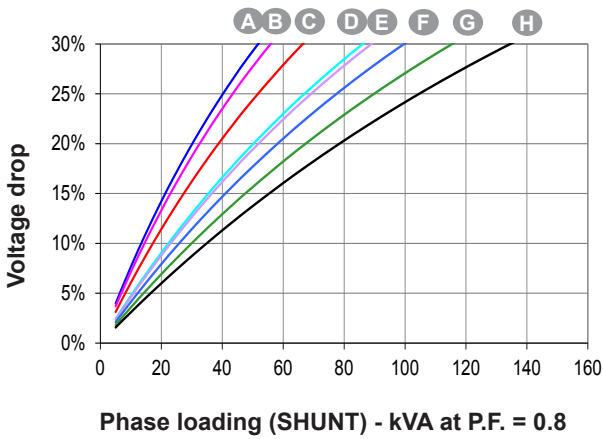

- 1) For a starting P.F. other than 0.6, the starting kVA must be multiplied by  $K = \text{Sine P.F.} / 0.8$
- 2) For voltages other than 480V (Y), 277V (Δ), 240V (YY) at 60 Hz, then kVA must be multiplied by  $(480/U)^2$  or  $(277/U)^2$  or  $(240/U)^2$ .

3-phase short-circuit curves at no load and rated speed (star connection Y)

TAL 042 A

Symmetrical —  
Asymmetrical - - -

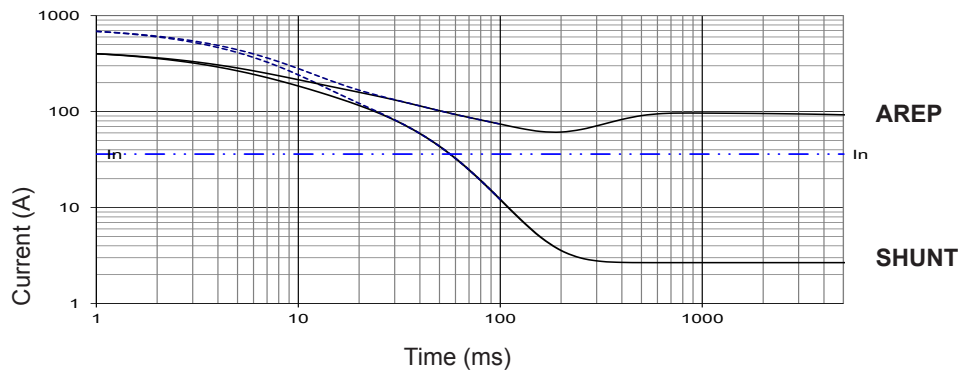

TAL 042 B

Symmetrical —  
Asymmetrical - - -

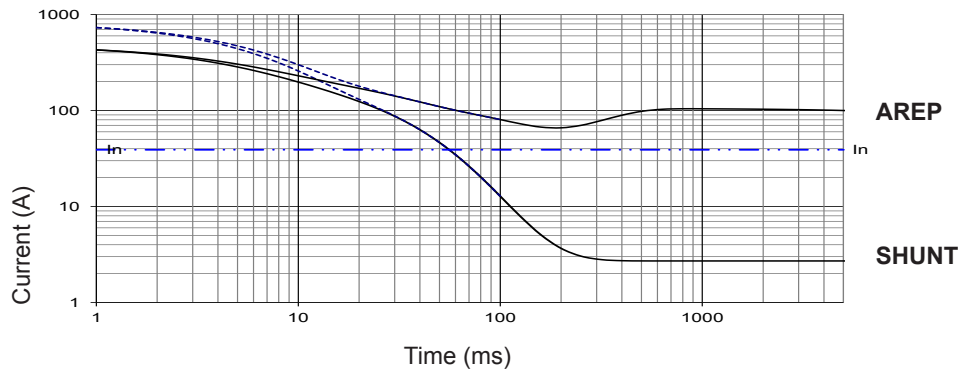

TAL 042 C

Symmetrical —  
Asymmetrical - - -

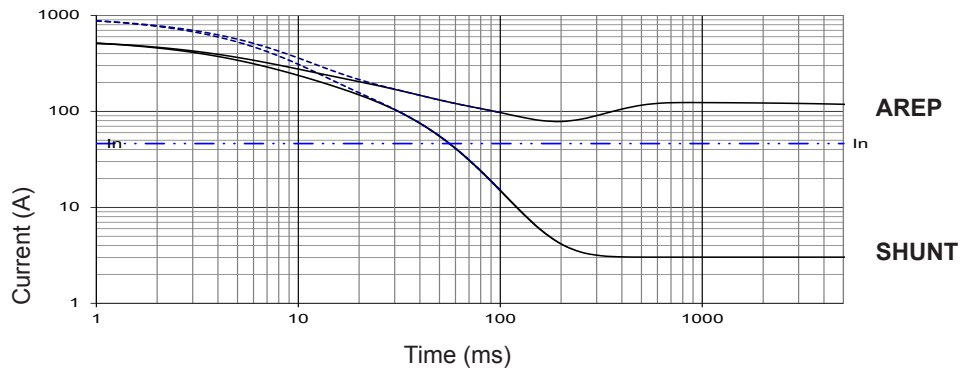

TAL 042 D

Symmetrical —  
Asymmetrical - - -

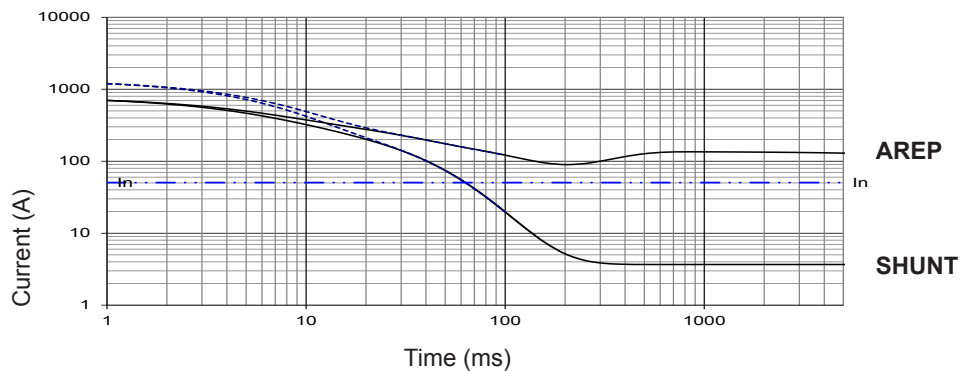

Influence due to connection

For (Δ) connection, use the following multiplication factor:  
- Current value x 1.732.

3-phase short-circuit curves at no load and rated speed (star connection Y)

**TAL 042 E**

Symmetrical —  
Asymmetrical - - -

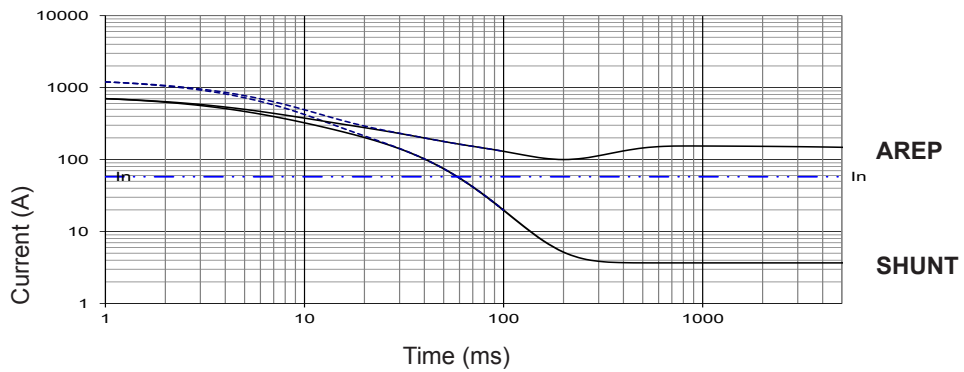

**TAL 042 F**

Symmetrical —  
Asymmetrical - - -

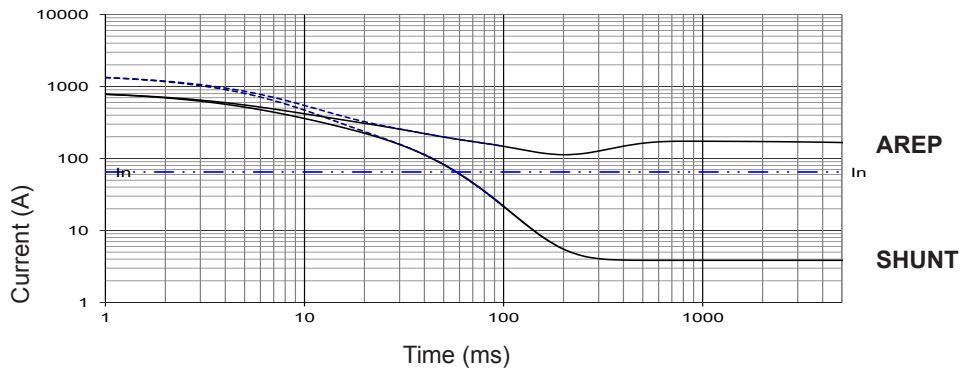

**TAL 042 G**

Symmetrical —  
Asymmetrical - - -

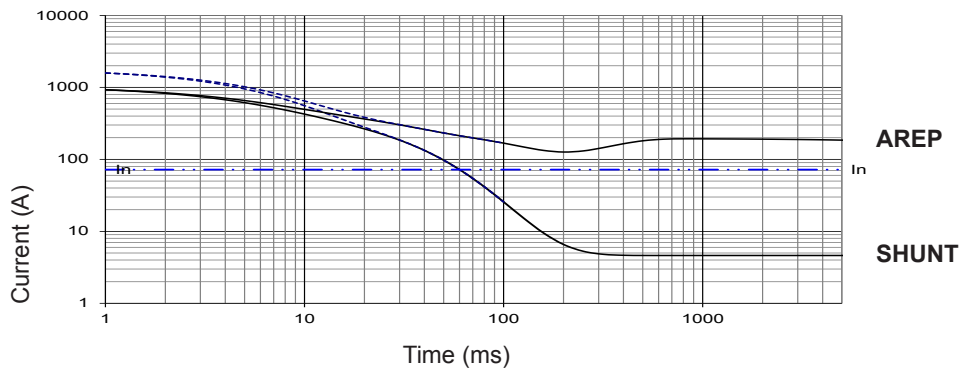

**TAL 042 H**

Symmetrical —  
Asymmetrical - - -

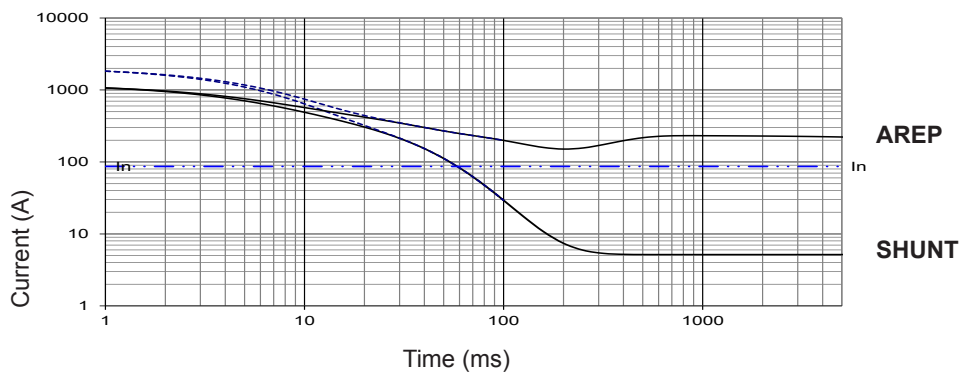

**Influence due to short-circuit**

Curves are based on a three-phase short-circuit.  
For other types of short-circuit,  
use the following multiplication factors.

	3 - phase	2 - phase L / L	1 - phase L / N
Instantaneous (max.)	1	0.87	1.3
Continuous	1	1.5	2.2
Maximum duration	1	1.5	



# TAL 042 - Dedicated single-phase 18 to 42 kVA - 50 Hz / 23 to 53 kVA - 60 Hz

## General characteristics



Insulation class	H	Excitation system	SHUNT
Winding pitch	2/3 (wind. M 50 Hz, M1 60 Hz)	AVR type	R121
Number of wires	4	Voltage regulation (*)	± 1 %
Protection	IP 23	Total Harmonic Distortion THD (**) in no-load	< 3.5 %
Altitude	≤ 1000 m	Total Harmonic Distortion THD (**) in linear load	< 5 %
Overspeed	2250 R.P.M.	Waveform: NEMA = TIF (**)	< 100
Air flow (m <sup>3</sup> /s)	50 Hz: 0.10 - 60 Hz: 0.13	Waveform: I.E.C. = FHT (**)	< 2 %

(\*) Steady state (\*\*) Total harmonic distortion between phases, no-load or on-load (non-distorting)

## Ratings / Efficiencies 50 Hz - 1500 R.P.M. - Winding M

kVA / kW - P.F. = 1 ( P.F. 0.8 : derating 15%)						
Duty / T° C	Continuous / 40 °C	Continuous / 40 °C	Stand-by / 40 °C	Stand-by / 27 °C		
Class / T° K	H / 125° K	F / 105° K	H / 150° K	H / 163° K		
Serie (SE) 	230 V	η %	230 V	230 V	230V	η %
Parallel (PA) 	115 V	η %	115 V	115 V	115 V	η %
<b>TAL 042 A</b>	18	88.1	16.5	19	20	87.4
<b>TAL 042 B</b>	20.5	88.1	18.5	21.5	22.5	87.4
<b>TAL 042 C</b>	22.5	89	20.5	24	25	88.4
<b>TAL 042 D</b>	25	90.6	23	26.5	27.5	90.2
<b>TAL 042 E</b>	28	90.1	25.5	29.5	31	89.6
<b>TAL 042 F</b>	31.5	90.3	28.5	33.5	34.5	89.8
<b>TAL 042 G</b>	35	90.4	32	37	38.5	89.9
<b>TAL 042 H</b>	42	90.5	38	44.5	46	90

## Ratings / Efficiencies 60 Hz - 1800 R.P.M. - Winding M1

kVA / kW - P.F. = 1 ( P.F. 0.8 : derating 15%)						
Duty / T° C	Continuous / 40 °C	Continuous / 40 °C	Stand-by / 40 °C	Stand-by / 27 °C		
Class / T° K	H / 125° K	F / 105° K	H / 150° K	H / 163° K		
Serie (SE) 	240 V	η %	240 V	240 V	240V	η %
Parallel (PA) 	120 V	η %	120 V	120 V	120 V	η %
<b>TAL 042 A</b>	23	88.3	21	24.5	25.5	87.7
<b>TAL 042 B</b>	26	88.3	23.5	27.5	28.5	87.6
<b>TAL 042 C</b>	29	89	26	30.5	32	88.5
<b>TAL 042 D</b>	31.5	90.4	28.5	33.5	34.5	90
<b>TAL 042 E</b>	36	89.8	33	38	39.5	89.2
<b>TAL 042 F</b>	40	90	36.5	42.5	44	89.5
<b>TAL 042 G</b>	47	90	43	50	51	89.5
<b>TAL 042 H</b>	53	90.5	48	56	58	90

## Starting motor 230V - 50Hz

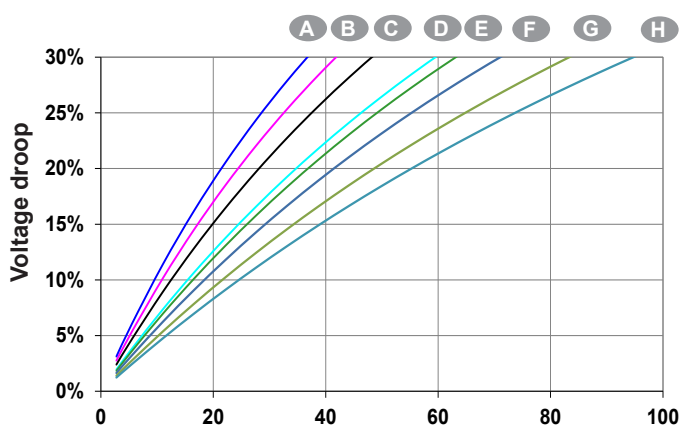

## Starting motor 240V - 60Hz

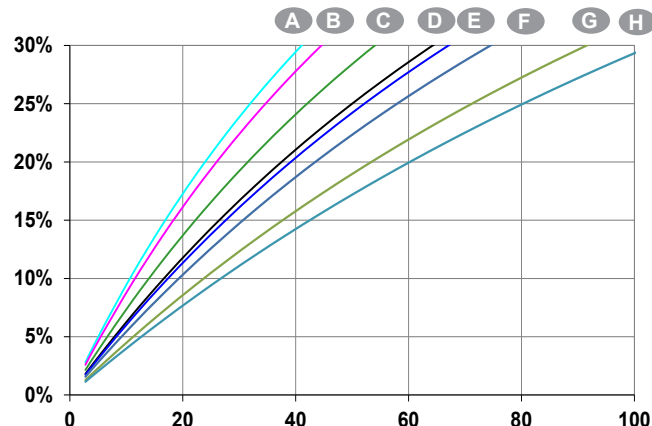

Locked rotor kVA at PF : 0.9



# TAL 042 - Three-phase & Single-phase

## Single bearing general arrangement

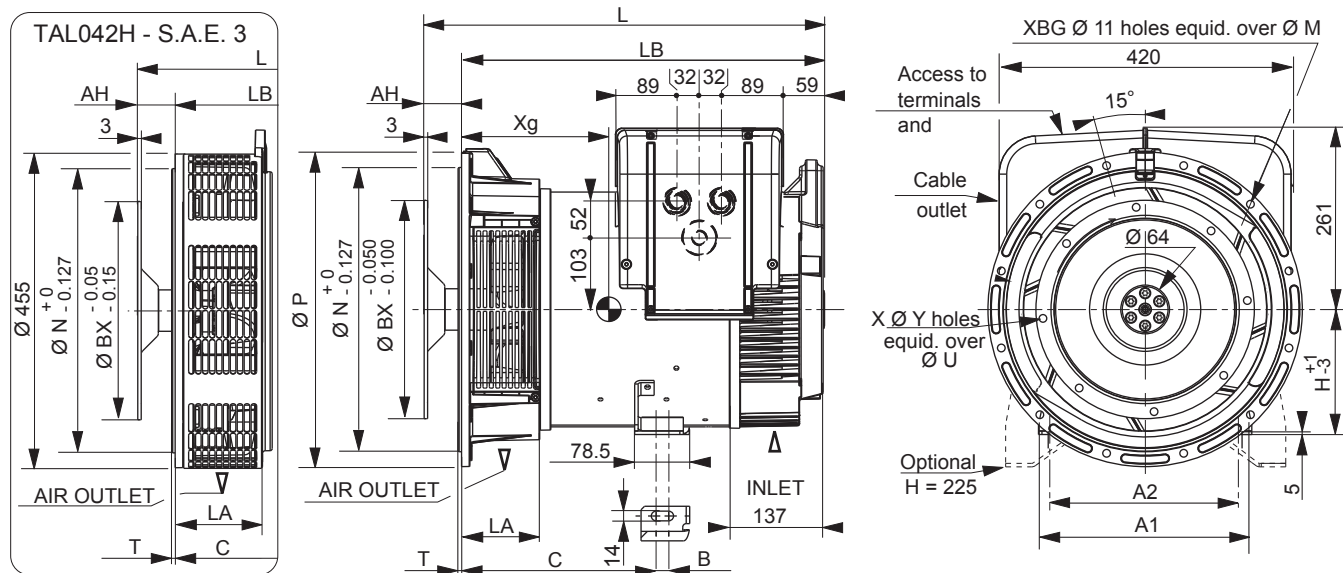

Dimensions (mm) and weight (kg)				
Type	L maxi	LB	Xg	Weight (kg)
TAL 042 A	565	503	237	117
TAL 042 B	565	503	242	122
TAL 042 C	565	503	252	133
TAL 042 D	610	548	275	165
TAL 042 E	610	548	275	165
TAL 042 F	650	588	287	181
TAL 042 G	650	588	295	186
TAL 042 H	680	618	310	187

Shaft height (mm)	
	Option
<b>H</b>	225
Feet length	
<b>C</b>	299 (A, B, C) / 312.5
<b>B</b>	23
<b>A1</b>	400
<b>A2</b>	356

Coupling		
Flange	3	4
Flex plate		
<b>11 1/2</b>	x	-
<b>10</b>	x	x
<b>8</b>	-	x
<b>7 1/2</b>	-	x

Flange (mm)						
S.A.E.	P	N	M	XBG	T	LA
4	406	361.95	381	12	6	122
3	452	409.58	428.62	12	5	105.3
-	-	-	-	-	-	-

Flex plate (mm)					
S.A.E.	BX	U	X	Y	AH
<b>11 1/2</b>	352.42	333.38	8	11	39.6
<b>10</b>	314.32	295.28	8	11	53.8
<b>8</b>	263.52	244.48	6	11	62
<b>7 1/2</b>	241.3	222.25	8	9	30.2

## Torsional data

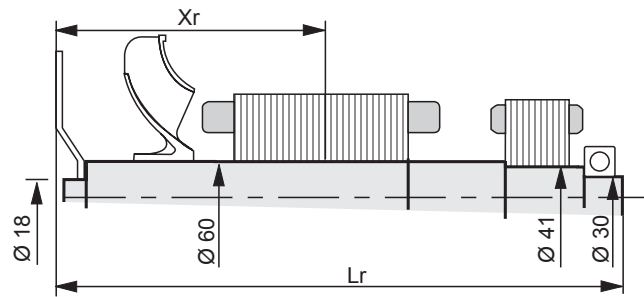

Centre of gravity: Xr (mm), Rotor length: Lr (mm), Weight: M (kg), Moment of inertia: J (kgm <sup>2</sup> ): (4J = MD <sup>2</sup> )																
Type	Flex plate S.A.E. 7 1/2				Flex plate S.A.E. 8				Flex plate S.A.E. 10				Flex plate S.A.E. 11 1/2			
	Xr	Lr	M	J	Xr	Lr	M	J	Xr	Lr	M	J	Xr	Lr	M	J
TAL 042 A	279	526.2	44.1	0.216	277	558	44.4	0.220	274	549.8	44.9	0.211	272	535.6	45.4	0.244
TAL 042 B	282	526.2	46.1	0.229	280	558	46.4	0.233	277	549.8	46.9	0.224	274	535.6	47.4	0.257
TAL 042 C	287	526.2	50.1	0.255	286	558	50.5	0.258	283	549.8	50.9	0.249	281	535.6	51.4	0.282
TAL 042 D	310	571.2	60.2	0.312	308	603	60.6	0.316	306	594.8	61	0.307	304	580.6	61.5	0.340
TAL 042 E	310	571.2	60.2	0.312	308	603	60.6	0.316	306	594.8	61	0.307	304	580.6	61.5	0.340
TAL 042 F	325	611.2	66.2	0.344	323	643	66.5	0.348	321	634.8	66.9	0.339	319	620.6	67.4	0.372
TAL 042 G	330	611.2	69.2	0.364	328	643	69.5	0.367	326	634.8	69.9	0.358	324	620.6	70.4	0.391
TAL 042 H	344	641.2	77.5	0.414	342	673	77.8	0.418	340	664.8	78.2	0.430	338	650.6	78.8	0.442

**NOTE** : Dimensions are for information only and may be subject to modifications. The torsional analysis of the transmission is imperative. All values are available upon request.

**LEROY-SOMER**<sup>™</sup>

[www.leroy-somer.com/epg](http://www.leroy-somer.com/epg)

[Linkedin.com/company/Leroy-Somer](https://www.linkedin.com/company/Leroy-Somer)  
[Twitter.com/Leroy\\_Somer\\_en](https://twitter.com/Leroy_Somer_en)  
[Facebook.com/LeroySomer.Nidec.en](https://www.facebook.com/LeroySomer.Nidec.en)  
[YouTube.com/LeroySomerOfficiel](https://www.youtube.com/LeroySomerOfficiel)



***Nidec***  
**All for dreams**

© Nidec 2018. The information contained in this brochure is for guidance only and does not form part of any contract. The accuracy cannot be guaranteed as Nidec have an ongoing process of development and reserve the right to change the specification of their products without notice.

Moteurs Leroy-Somer SAS. Siège : Bd Marcellin Leroy, CS 10015, 16915 Angoulême Cedex 9, France.  
Capital social : 65 800 512 €, RCS Angoulême 338 567 258.

# InteliLite<sup>NT</sup> AMF 9



## SINGLE SET GEN-SET CONTROLLER

### Description

The InteliLite<sup>NT</sup> AMF 9 is integrated controller for gen-sets operating in single standby mode.

The controller meets all requirements for Auto Mains Failure (AMF) applications including remote communication and internet control, user configuration and complete gen-set monitoring and protection.

InteliLite<sup>NT</sup> AMF 9 is easy to use with a simple intuitive user interface and graphic display. Unit is designed for quick and cost saving commissioning and bring seamless integration with the latest breed of EFI diesel engines from all major manufacturers. This offers a higher level of functionality with users able to display a comprehensive range of values from the EFI engine on standard analog gauges and true RMS measurement of electric values.

### Benefits

- ▶ Less wiring and components
- ▶ Less engineering and programming
- ▶ Cost saving commissioning
- ▶ Remote monitoring reduced call-out costs of service engineers
- ▶ History 100+ records based on running hours
- ▶ Hybrid binary inputs and outputs module – simple way of extension the unit performance
- ▶ SMS on alarm/event
- ▶ Direct communication with EFI engines
- ▶ Perfect price/performance ratio



#### InteliLite<sup>NT</sup> AMF 9 supports J1939 for all major brands:

- |                  |              |           |                          |
|------------------|--------------|-----------|--------------------------|
| • Caterpillar    | • GM         | • MAN     | • Sisu                   |
| • Cummins        | • Isuzu      | • MTU     | • VM Motori              |
| • Detroit Diesel | • Iveco      | • Perkins | • Volvo Penta and others |
| • Deutz          | • John Deere | • Scania  |                          |



ComAp is a member of AMPS (The Association of Manufacturers of Power generating Systems).



ComAp products meet the highest standards, with every stage of production undertaken in accordance with the ISO certification obtained in 1998.

## Features

### 3 phase AMF function

- Over/Under frequency
- Over/Under voltage

### 3 phase generator protections

- Over/Under frequency
- Over/Under voltage
- Over current

### True RMS Voltage measurement

- 3 phase generator voltages:
  - Phase to neutral  
L1 – N, L2 – N, L3 – N
  - Phase to phase  
L1 – L2, L2 – L3, L3 – L1
- 3 phase mains voltages
- Voltage range 277 V p-n, 480 V p-p
- Maximal measured voltage 300 V p-n

### True RMS current measurements

- 3 generator phase currents
- Current range 5 A
- Maximal measured current 10 A
- Ready for generators with 3 ph 4 wires / 3 ph 3 wires / Split ph / Mono ph

### Event and performance log

- Gen-set text alarm log
- Engine hours history log
- ECU text alarm log
- Test Run scheduler

### Power measurements

- Apparent power per phase
- Total apparent power

### User interface

- Graphic 128 x 64 pixels display
- 2 languages, user changeable from PC
- Setpoints adjustable via controller buttons or PC
- Buttons with mechanical feedback

### Inputs and outputs

- 3 fully configurable analog inputs
- 4 binary inputs; 6 binary outputs
- D+ preexcitation terminal
- Optional 8 hybrid binary inputs/outputs
- Optional 8 analog gauge drive outputs, compatible with VDO, Datcon gauges

### EFI engine support

- Cummins Modbus
- Engine specific J1939 for all major manufacturers (see table on page 1)
- Diagnostic messages in plain text

### Engine protections

- Oil pressure protection
- Coolant temperature
- Fuel level

### Active calls

- 1 channel
- SMS alarm
- Event SMS

### Miscellaneous features

- Operation mode – AMF/MRS application switch
- Maintenance – service time counter
- Engine hours counter

### Communication interfaces

- Optional RS232, RS485 (including Modem support) or USB plug-in interface
- Optional GSM modem via IL-NT GPRS

### Mechanical

#### and operation parameters

- Unit dimension 120 x 180 mm
- Sealed front face rated for IP65
- Hard plexiglass LCD cover
- Operation temperature:
  - -20 °C to +70 °C standard version
  - -40 °C to +70 °C low temperature ver.
- Power supply voltage 8–36 V
- Voltage drops shorter than 50 ms do not affect operation

ANSI code	Protection
59	Overvoltage
27	Undervoltage
81H	Overfrequency
81L	Underfrequency
50+51	Overcurrent*
47	Phase rotation**
71	Gas (Fuel) level

\* Shortcurrent only / \*\* Fixed setting

## Schematic diagram

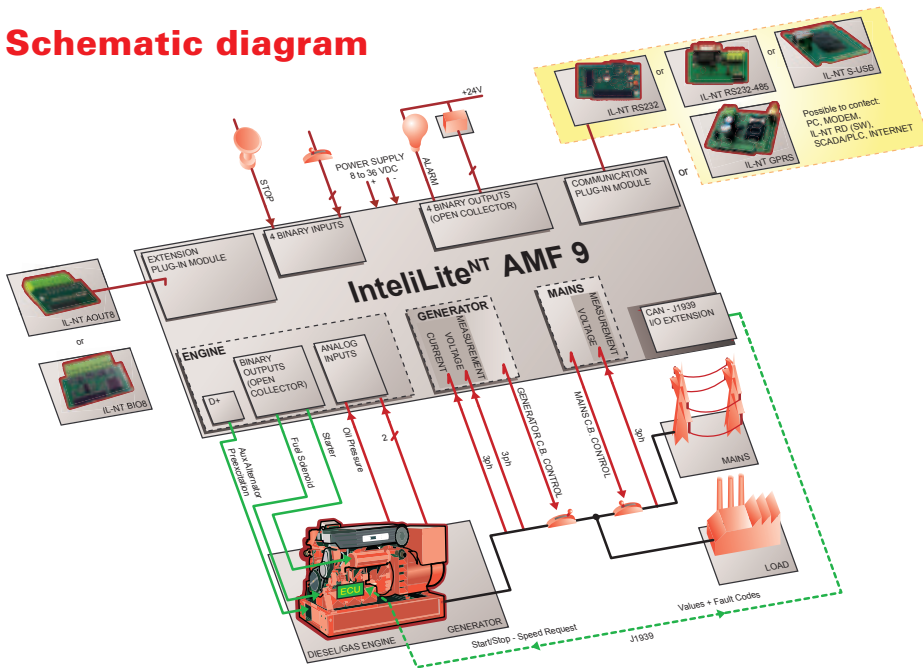

## Accessories and PC tools

- ▷ **IL-NT AOUT8** – Analog Outputs for PWM Gauges Module
- ▷ **IL-NT BIO8** – Binary Input/Output (PWM) Module
- ▷ **IL-NT RD (SW)** – Remote Display Software for IntelLite<sup>NT</sup> Controllers
- ▷ **IG-IB** – InternetBridge support
- ▷ **IL-NT GPRS** – GSM Modem/Wireless Internet Module
- ▷ **IL-NT RS232** – RS232 Extension Board
- ▷ **IL-NT RS232-485** – Dual Port Extension Board
- ▷ **IL-NT S-USB** – Service USB Module
- ▷ **InteliMonitor** – PC Monitoring Tool
- ▷ **WinScope** – Special Graphical Controllers' Monitoring Software
- ▷ **LiteEdit** – PC Configuration and Monitoring Tool



MANUFACTURER:

**ComAp, spol. s r.o.**

Czech Republic

Phone: + 420 246 012 111

Fax: + 420 266 316 647

E-mail: [info@comap.cz](mailto:info@comap.cz)

Internet: [www.comap.cz](http://www.comap.cz)

LOCAL DISTRIBUTOR / PARTNER:



**Customer satisfaction is our mission. We continuously develop the best people to succeed in our mission.**