

# PERKINS GENERATOR

91 KVA ( 73 KW )

(UK)

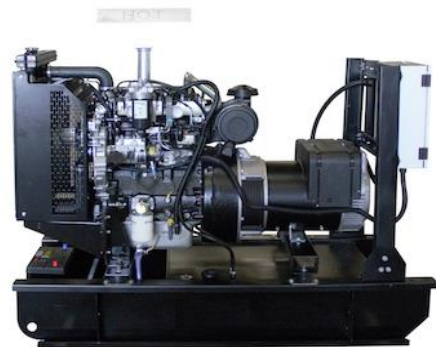

# 1100 Series 1104A-44TG2 Diesel Engine – Electropak

90.2 kWm / 121.0 hp @ 1800 rpm

Building upon Perkins proven reputation within the power generation industry, the 1100 Series range of Electropak engines now fit even closer to customers needs.

In the world of power generation success is only gained by providing more for less. With the 1104A-44TG2 Perkins has engineered even higher levels of reliability, yet lowered the cost of ownership.

1100A units are designed for territories that do not require compliance to EPA or EU emissions legislation. These units are able to meet TA luft legislation.



Specification		
Number of cylinders	4 vertical in-line	
Bore and stroke	105 x 127 mm	4.1 x 5 in
Displacement	4.4 litres	268.5 in <sup>3</sup>
Aspiration	Turbocharged	
Cycle	4 stroke	
Combustion system	Direct injection	
Compression ratio	17.25:1	
Rotation	Anti-clockwise, viewed from flywheel	
Total lubricating capacity	8.0 litres	2.1 US gal
Cooling system	Water-cooled	
Total coolant capacity	13.0 litres	3.4 US gal

[www.perkins.com](http://www.perkins.com)

Photographs are for illustrative purposes only and may not reflect final specification. All information in this document is substantially correct at time of printing and may be altered subsequently. Final weight and dimensions will depend on completed specification.

Publication No. PN1784B/12/14 Produced in England ©2014 Perkins Engines Company Limited

 **Perkins**<sup>®</sup>

THE HEART OF EVERY GREAT MACHINE

# 1100 Series 1104A-44TG2 Diesel Engine – ElectropaK

90.2 kWm / 121.0 hp @ 1800 rpm

## Features and benefits

### Compact, efficient power

- 1100 Series is the result of an intensive period of customer research that has guided the development of the range
- The new 4.4 litre cylinder block ensures bore roundness is maintained under the pressures of operation. It also ensures combustion and mechanical noise is lowered
- A new cylinder head has re-established Perkins mastery of air control

### Quality by design

- Product design and Class A manufacturing improvements enhance product reliability while maintaining Perkins legendary reputation for durability

### Cost effective power

- Compact size and low noise
- Lower fuel consumption and oil use
- 500 hour service intervals
- **Warranties and Service Contracts**

We provide one-year warranties for constant speed engines and two-year warranties for variable speed models, as standard. These are supported by multilevel Extended Service Contracts that can be bought additionally

Discover more: [www.perkins.esc](http://www.perkins.esc)

### Product support

- Perkins actively pursues product support excellence by ensuring our distribution network invest in their territory – strengthening relationships and providing more value to you, our customer
- Through an experienced global network of distributors and dealers, fully trained engine experts deliver total service support around the clock, 365 days a year. They have a comprehensive suite of web based tools at their fingertips covering technical information, parts identification and ordering systems, all dedicated to maximising the productivity of your engine
- Throughout the entire life of a Perkins engine, we provide access to genuine OE specification parts and service. We give 100% reassurance that you receive the very best in terms of quality for lowest possible cost .. wherever your Perkins powered machine is operating in the world
- To find your local distributor: [www.perkins.com/distributor](http://www.perkins.com/distributor)

[www.perkins.com](http://www.perkins.com)

Photographs are for illustrative purposes only and may not reflect final specification.  
All information in this document is substantially correct at time of printing and may be altered subsequently.  
Final weight and dimensions will depend on completed specification.

Publication No. PN1784B/12/14 Produced in England ©2014 Perkins Engines Company Limited

 **Perkins**<sup>®</sup>

THE HEART OF EVERY GREAT MACHINE

# 1100 Series 1104A-44TG2 Diesel Engine – ElectropaK

90.2 kWm / 121.0 hp @ 1800 rpm

## Technical information

### Air inlet

- Mounted air filter

### Fuel system

- Rotary type pump
- EcoPlus fuel filter

### Lubrication system

- Wet sump with filler and dipstick
- Spin-on oil filter

### Cooling system

- Thermostatically controlled system with gear-driven circulation pump and belt-driven pusher fan
- Mounted radiator and piping

### Electrical equipment

- 12 volt starter motor and 12 volt 65 amp alternator with DC output
- 12 volt shutdown solenoid energised to run

### Flywheel and housing

- High inertia flywheel to SAE J620 Size 10/11½
- SAE 3 flywheel housing

### Mountings

- Front engine mounting bracket

### Literature

- User's Handbook

### Optional equipment

- Woodward electronic governor (LCG2)
- Workshop manual
- Parts book

[www.perkins.com](http://www.perkins.com)

Photographs are for illustrative purposes only and may not reflect final specification.  
All information in this document is substantially correct at time of printing and may be altered subsequently.  
Final weight and dimensions will depend on completed specification.

Publication No. PN1784B/12/14 Produced in England ©2014 Perkins Engines Company Limited

 **Perkins**<sup>®</sup>

THE HEART OF EVERY GREAT MACHINE

# 1100 Series 1104A-44TG2 Diesel Engine – ElectropaK

90.2 kWm / 121.0 hp @ 1800 rpm

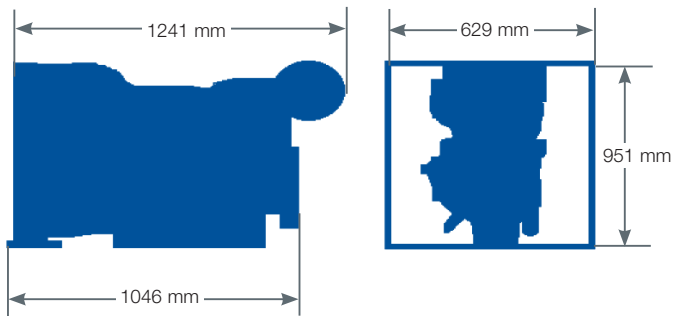

Engine package weights and dimensions

Length	1241 mm	48.8 in
Width	629 mm	24.7 in
Height	951 mm	37.4 in
Weight (dry)	463 kg	1021 lb

[www.perkins.com](http://www.perkins.com)

Photographs are for illustrative purposes only and may not reflect final specification.  
All information in this document is substantially correct at time of printing and may be altered subsequently.  
Final weight and dimensions will depend on completed specification.

Publication No. PN1784B/12/14 Produced in England ©2014 Perkins Engines Company Limited

 **Perkins**<sup>®</sup>

THE HEART OF EVERY GREAT MACHINE

# 1100 Series 1104A-44TG2 Diesel Engine – Electropak

90.2 kWm / 121.0 hp @ 1800 rpm

Speed rpm	Type of operation	Typical generator output (Net)		Engine power			
				Gross		Net	
		kVA	kWe	kWm	hp	kWm	hp
1800	Prime power	91.3	73.0	84.5	113.3	82.0	109.9
	Standby power	100.3	80.3	93.0	124.7	90.2	121.0

The above ratings represent the engine performance capabilities to conditions specified in ISO 8528/1, ISO 3046/1:1986, BS5514/1. Derating may be required for conditions outside these; consult Perkins Engines Company Limited.

Generator powers are typical and are based on an average alternator efficiency and a power factor (cos.  $\theta$ ) of 0.8. Fuel specification: BS 2869: Part 2 1998 Class A2 or DIN EN 590. Lubricating oil: 15W40 to API CG4.

#### Rating definitions

**Prime power:** Variable load. Unlimited hours usage with an average load factor of 80% of the published prime power over each 24 hour period. A 10% overload is available for 1 hour in every 12 hours of operation. **Standby power:** Variable load. Limited to 500 hours annual usage, up to 300 hours of which may be continuous running. No overload is permitted.

Percent of prime power	Fuel consumption at 1800 rpm g/kWh	Fuel consumption at 1800 rpm l/hr
110%	5.3	24.4
100%	4.9	22.3
75%	3.7	16.9
50%	2.6	11.9

[www.perkins.com](http://www.perkins.com)

Photographs are for illustrative purposes only and may not reflect final specification. All information in this document is substantially correct at time of printing and may be altered subsequently. Final weight and dimensions will depend on completed specification.

Publication No. PN1784B/12/14 Produced in England ©2014 Perkins Engines Company Limited



THE HEART OF EVERY GREAT MACHINE

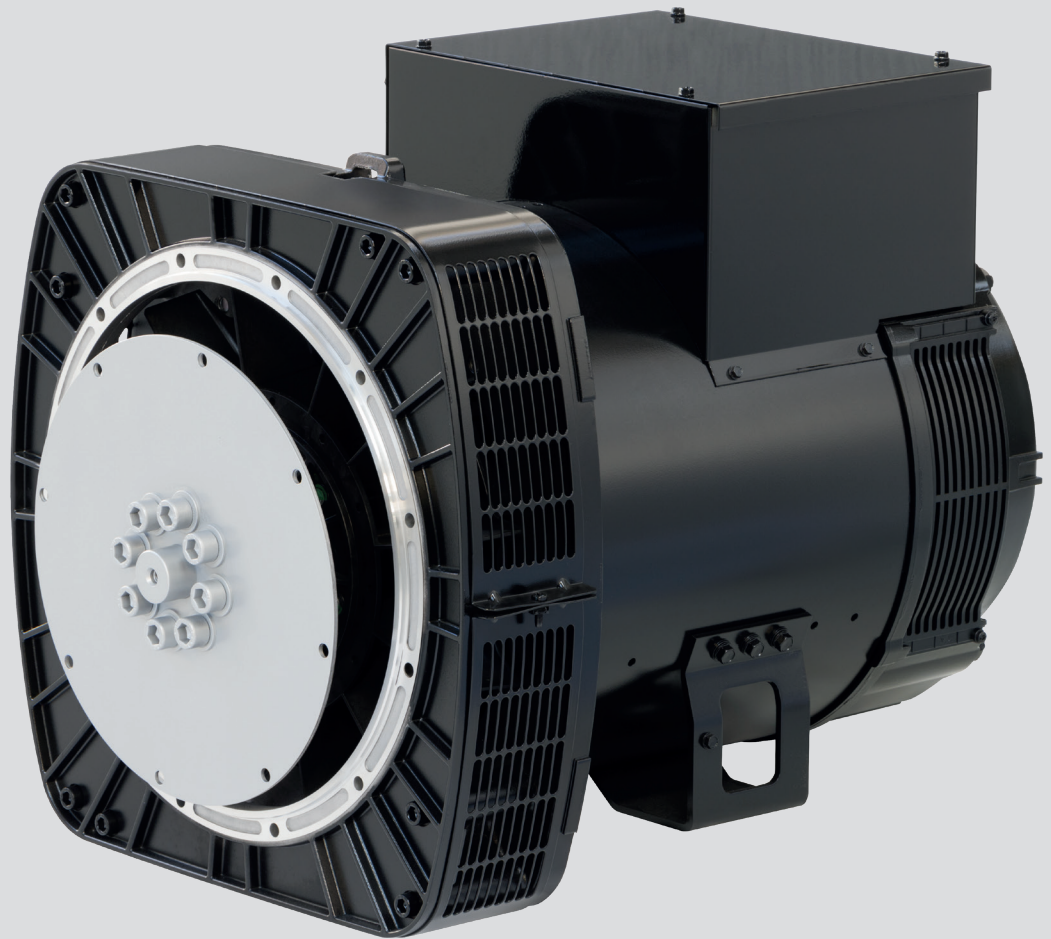

**TAL 044**

## **Low Voltage Alternator - 4 pole**

Three-phase 70 to 165 kVA - 50 Hz / 88 to 206 kVA - 60 Hz  
Dedicated single-phase 57 to 82 kVA - 50 Hz / 80 to 125 kVA - 60 Hz  
Electrical and mechanical data

**LEROY-SOMER**<sup>™</sup>

***Nidec***  
All for dreams

# TAL 044 - Three-phase & Single-phase

## Adapted to needs

The TAL alternator range is designed to meet the needs of general applications such as prime power and stand-by.

## Compliant with international standards

The TAL range complies with international standards and regulations: IEC 60034 and derivative.

The range is designed, manufactured and marketed in an ISO 9001 and 14001 environment.

## Electrical design

- Class H insulation
- Shunt excitation
- Low voltage winding:
  - Three-phase 50 Hz: 380V - 400V - 415V - 440V / 220V - 230V - 240V
  - 60 Hz: 380V - 416V - 440V - 480V / 220V - 208V - 240V
- Single-phase 50 Hz: 230V
- 60 Hz: 240V
- 4-terminal plates in 6-wire version
- Optimized performance

## Robust design

- Compact and rugged assembly to withstand engine vibrations
- Steel frame
- Aluminum flanges and shields
- Single bearing design compatible with most diesel engines
- Sealed for life single bearing
- Direction of rotation: clockwise and counterclockwise without derating



## Excitation and regulation system suited to the application

	Excitation system				Regulation options		
	AVR	Shunt	AREP	PMG	ULC/US	Remote voltage potentiometer	C.T. for paralleling
Three-phase 6-wire	R120	Standard					
	R150	Option				√	
	R180		Standard	Standard		√	√
	R438		Option	Option	√	√	√
Three-phase 12-wire	R120	Standard					
	R250	Option			√	√	
	R180		Standard	Standard		√	√
	R438		Option	Option	√	√	√
Single-phase	R121	Standard				√	
	R250	Option			√	√	

√: Possible option

## Compact terminal box

- Easy access to AVR and terminals
- Possibility of current transformer for parallel operation

## Environment and protection

- IP Code IP 23
- Standard winding protection for non-harsh environment with relative humidity  $\leq 95\%$

## Available options

- Three-phase 12-wire with 8-terminal plates
- AREP or PMG excitation
- ULC/us
- Customized painting (machine not painted as standard)
- Space heaters
- Flying leads
- Droop kit for alternator paralleling
- Dedicated single-phase
- Stator sensors
- Winding 8 optimized for three-phase 380V / 416V - 60Hz
- Winding protection for harsh environments and relative humidity greater than 95% (system 2 - 4 without derating): for TAL 044 K apply a derating coefficient of 0.97



# TAL 044 - Three-phase 70 to 165 kVA - 50 Hz / 88 to 206 kVA - 60 Hz

## General characteristics

Insulation class	H	Excitation system 6-wire	SHUNT	AREP
Winding pitch	2/3 (wind.6S - 6-wire / wind.6 - 12-wire)	AVR type	R120	R180
Number of wires	6-wire (12-wire option)	Excitation system 12-wire (option)	SHUNT	AREP
Protection	IP 23	AVR type	R120	R180
Altitude	≤ 1000 m	Voltage regulation (*)	± 1 %	
Overspeed	2250 R.P.M.	Total Harmonic Distortion THD (**) in no-load	< 2 %	
Air flow 50 Hz (m³/s)	0.25	Total Harmonic Distortion THD (**) in linear load	< 5 %	
Air flow 60 Hz (m³/s)	0.30	Waveform: NEMA = TIF (**)	< 50	
AREP Short-circuit current = 2.7 In : 5 second		Waveform: I.E.C. = FHT (**)	< 2%	

(\*) Steady state (\*\*) Total harmonic distortion between phases, no-load or on-load (non-distorting)

## Ratings 50 Hz - 1500 R.P.M.

kVA / kW - P.F. = 0.8

Duty / T° C	Continuous / 40 °C					Continuous / 40 °C					Stand-by / 40 °C					Stand-by / 27 °C					
Class / T° K	H / 125° K					F / 105° K					H / 150° K					H / 163° K					
Phase	3 ph.			1 ph.		3 ph.			1 ph.		3 ph.			1 ph.		3 ph.			1 ph.		
<b>Y</b>	380V	400V	415V	440V		380V	400V	415V	440V		380V	400V	415V	440V		380V	400V	415V	440V		
<b>Δ</b>	220V	230V	240V		230V	220V	230V	240V		230V	220V	230V	240V		230V	220V	230V	240V		230V	
<b>YY (*)</b>					220V					220V					220V					220V	
<b>ΔΔ (*)</b>					230V					230V					230V					230V	
<b>TAL 044 A</b>	kVA	70	70	70	63	42	64	64	64	57	38	74	74	74	67	45	77	77	77	69	46
	kW	56	56	56	50	33.5	51	51	51	46	30.5	59	59	59	53	36	62	62	62	55	37
<b>TAL 044 B</b>	kVA	80	80	80	72	48	73	73	73	66	44	85	85	85	76	51	88	88	88	79	53
	kW	64	64	64	58	38.5	58	58	58	53	35	68	68	68	61	41	70	70	70	63	42
<b>TAL 044 C</b>	kVA	90	90	90	81	54	82	82	82	74	49	95	95	95	86	57	100	100	100	89	59
	kW	72	72	72	65	43	66	66	66	59	39	76	76	76	68	46	80	80	80	71	47
<b>TAL 044 D</b>	kVA	100	100	100	90	60	91	91	91	82	55	106	106	106	95	64	110	110	110	99	66
	kW	80	80	80	72	48	73	73	73	66	44	85	85	85	76	51	88	88	88	79	53
<b>TAL 044 E</b>	kVA	125	125	125	113	67	114	114	114	103	61	133	133	133	120	71	138	138	138	124	74
	kW	100	100	100	90	54	91	91	91	82	49	106	106	106	94	57	110	110	110	99	59
<b>TAL 044 H</b>	kVA	135	135	135	122	73	123	123	123	111	66	143	143	143	129	77	150	150	150	134	80
	kW	108	108	108	98	58	98	98	98	89	53	114	114	114	102	62	120	120	120	107	64
<b>TAL 044 J</b>	kVA	150	150	150	135	80	137	137	137	123	73	159	159	159	143	85	165	165	165	149	88
	kW	120	120	120	108	64	110	110	110	98	58	127	127	127	114	68	132	132	132	119	70
<b>TAL 044 K</b>	kVA	165	165	165	138	88	150	150	150	126	80	175	175	175	150	93	182	182	182	157	97
	kW	132	132	132	110	70	120	120	120	100	64	140	140	140	120	74	145	145	145	126	78

(\*) 12-wire option

## Ratings 60 Hz - 1800 R.P.M.

kVA / kW - P.F. = 0.8

Duty / T° C	Continuous / 40 °C					Continuous / 40 °C					Stand-by / 40 °C					Stand-by / 27 °C					
Class / T° K	H / 125° K					F / 105° K					H / 150° K					H / 163° K					
Phase	3 ph.			1 ph.		3 ph.			1 ph.		3 ph.			1 ph.		3 ph.			1 ph.		
<b>Y</b>	380V	416V	440V	480V		380V	416V	440V	480V		380V	416V	440V	480V		380V	416V	440V	480V		
<b>Δ</b>	220V	240V		240V		220V	240V		240V		220V	240V		240V		220V	240V		240V		
<b>YY (*)</b>					240V					240V					240V					240V	
<b>ΔΔ (*)</b>					240V					240V					240V					240V	
<b>TAL 044 A</b>	kVA	69	76	80	88	46	63	69	73	80	42	73	81	85	93	49	76	84	88	97	51
	kW	55	61	64	70	37	50	55	58	64	33.6	58	65	68	74	39.2	61	67	70	78	41
<b>TAL 044 B</b>	kVA	79	87	92	100	52	72	79	84	91	47	84	92	98	106	55	87	96	101	110	57
	kW	63	70	74	80	42	58	63	67	73	37.6	67	74	78	85	44	70	77	81	88	46
<b>TAL 044 C</b>	kVA	89	98	103	113	59	81	89	94	103	54	94	104	109	120	63	98	108	113	124	65
	kW	71	78	82	90	47	65	71	75	82	43	75	83	87	96	50	78	86	90	99	52
<b>TAL 044 D</b>	kVA	99	108	115	125	65	90	98	105	114	59	105	114	122	133	69	109	119	127	138	72
	kW	79	86	92	100	52	72	78	84	91	47	84	91	98	106	55	87	95	102	110	58
<b>TAL 044 E</b>	kVA	124	135	143	156	76	113	123	130	142	69	131	143	152	165	81	136	149	157	172	84
	kW	99	108	114	125	61	90	98	104	114	55	105	114	122	132	65	109	119	126	138	67
<b>TAL 044 H</b>	kVA	134	146	155	169	81	122	133	141	154	74	142	155	164	179	86	147	161	171	186	89
	kW	107	117	124	135	65	98	106	113	123	59	114	124	131	143	69	118	129	137	149	71
<b>TAL 044 J</b>	kVA	148	163	172	188	95	135	148	157	171	86	157	173	182	199	101	163	179	189	207	105
	kW	118	130	138	150	76	108	118	126	137	69	126	138	146	159	81	130	143	151	166	84
<b>TAL 044 K</b>	kVA	165	179	189	206	105	150	163	172	187	96	175	190	200	218	111	182	197	208	227	116
	kW	132	143	151	165	84	118	130	138	150	77	138	152	160	174	89	143	158	166	182	93

(\*) 12-wire option

## Efficiencies 400 V - 50 Hz (— P.F.: 0.8) (----- P.F.: 1)

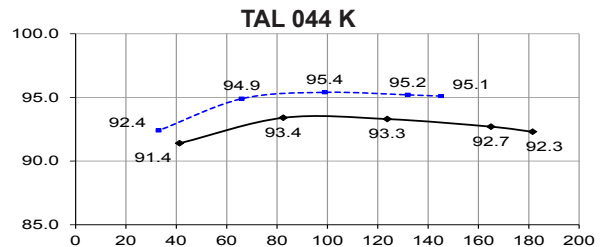
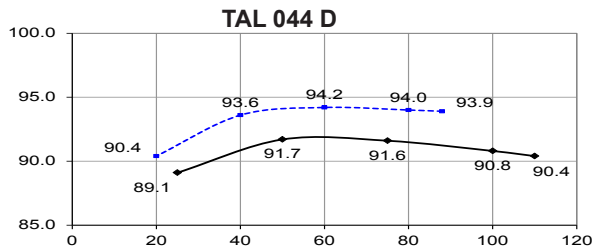
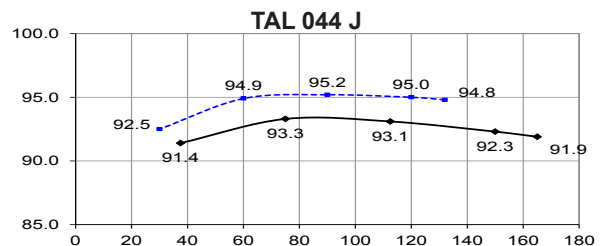
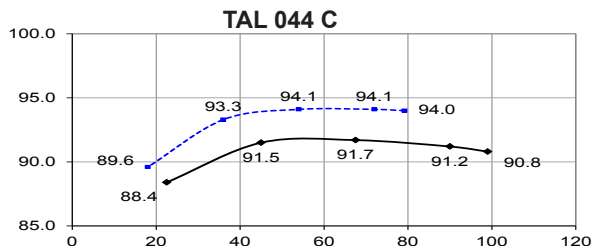
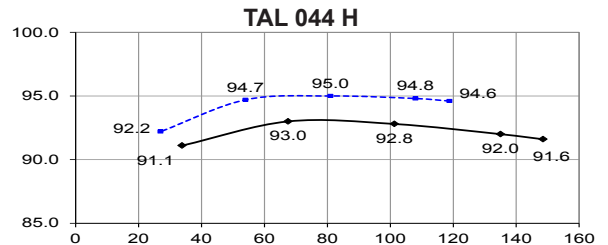
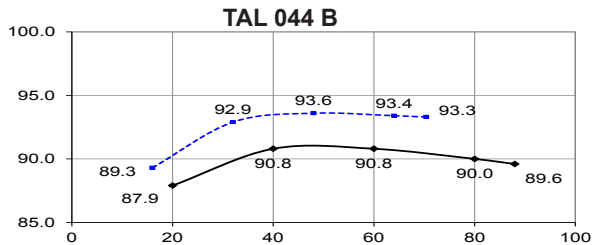
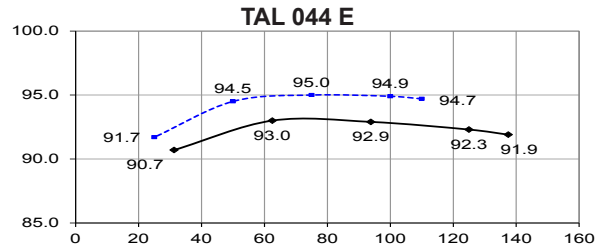
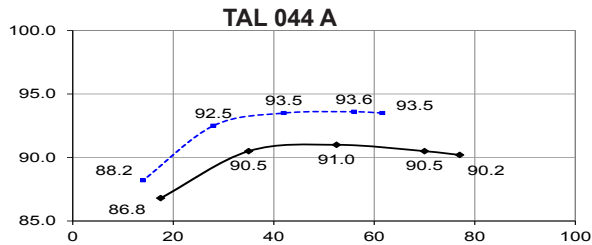

## Reactances (%). Time constants (ms) - Class H / 400 V

	A	B	C	D	E	H	J	K
<b>Kcc</b> Short-circuit ratio	0.57	0.5	0.53	0.48	0.43	0.4	0.4	0.42
<b>Xd</b> Direct-axis synchro. reactance unsaturated	294	336	307	341	334	361	359	343
<b>Xq</b> Quadrature-axis synchro. reactance unsaturated	150	171	156	174	170	184	183	175
<b>T'do</b> No-load transient time constant	2475	2475	2308	2308	2154	2154	2112	2077
<b>X'd</b> Direct-axis transient reactance saturated	11.9	13.6	13.3	14.7	15.5	16.7	17	16.5
<b>T'd</b> Short-circuit transient time constant	100	100	100	100	100	100	100	100
<b>X''d</b> Direct-axis subtransient reactance saturated	7.1	8.1	7.9	8.8	9.3	10	10.2	9.9
<b>T''d</b> Subtransient time constant	10	10	10	10	10	10	10	10
<b>X''q</b> Quadrature-axis subtransient reactance saturated	16.1	18.3	17	18.9	18.9	20.4	20.4	19.5
<b>Xo</b> Zero sequence reactance	0.49	0.56	0.55	0.61	0.64	0.69	0.7	0.68
<b>X2</b> Negative sequence reactance saturated	11.62	13.28	12.53	13.92	14.12	15.25	15.31	14.74
<b>Ta</b> Armature time constant	15	15	15	15	15	15	15	15

## Other class H / 400 V data

<b>io (A)</b> No-load excitation current SHUNT and AREP	0.84/1.08	0.84/1.08	0.8/1.03	0.8/1.03	0.67/0.87	0.67/0.87	0.66/0.85	0.68/0.88
<b>ic (A)</b> On-load excitation current SHUNT and AREP	2.6/3.35	2.95/3.8	2.75/3.54	3.08/3.96	2.57/3.31	2.78/3.59	2.79/3.6	2.82/3.63
<b>uc (V)</b> On-load excitation voltage SHUNT and AREP	28.9/23.2	32.5/26.1	30.1/24.1	33.2/26.7	31.9/25.6	34.3/27.5	34.1/27.4	34.1/27.4
<b>ms</b> Response time ( $\Delta U = 20\%$ transient)	500	500	500	500	500	500	500	500
<b>kVA</b> Start ( $\Delta U = 20\%$ cont. or $\Delta U = 30\%$ trans.) SHUNT*	124.4	123.9	143.1	143.2	204	204.8	224.9	253.8
<b>kVA</b> Start ( $\Delta U = 20\%$ cont. or $\Delta U = 30\%$ trans.) AREP*	149.2	149.4	171.4	171.2	246.2	245.1	269.1	296.2
<b>%</b> Transient $\Delta U$ (on-load 4/4) SHUNT - P.F.: 0.8 <sub>LAG</sub>	17.2	18.8	18.5	19.9	18.2	19.1	19.3	18.9
<b>%</b> Transient $\Delta U$ (on-load 4/4) AREP - P.F.: 0.8 <sub>LAG</sub>	15.2	16.6	16.4	17.6	16.1	16.9	17.1	16.7
<b>W</b> No-load losses	1943	1943	2142	2142	2292	2292	2450	2755
<b>W</b> Heat dissipation	5845	7033	6927	8059	8323	9340	9913	10366

\* P.F. = 0.6

Transient voltage variation 400V - 50 Hz

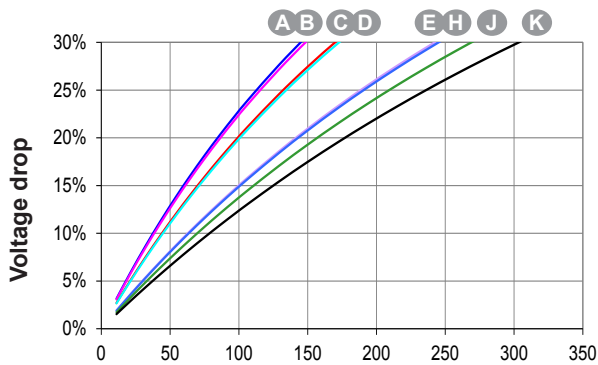

Phase loading (SHUNT) - kVA at P.F. = 0.8

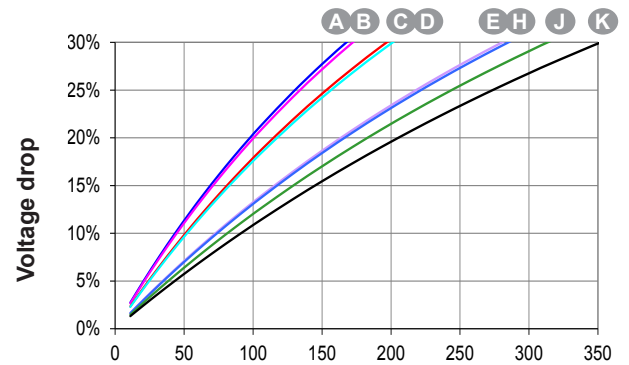

Phase loading (AREP) - kVA at P.F. = 0.8

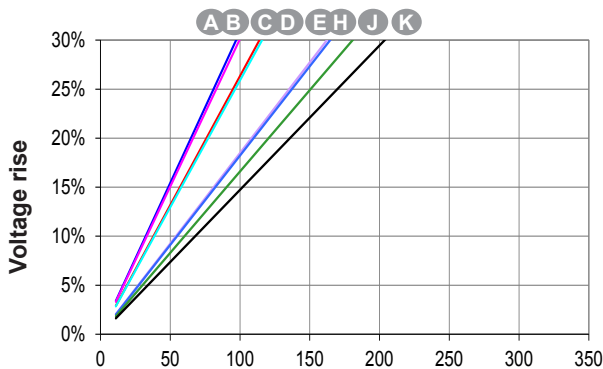

Load shedding (SHUNT) - kVA at P.F. = 0.8

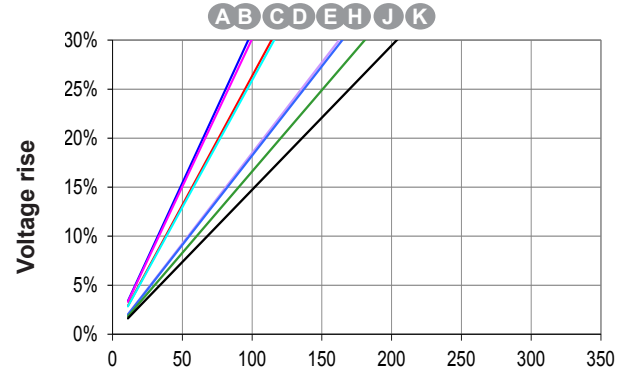

Load shedding (AREP) - kVA at P.F. = 0.8

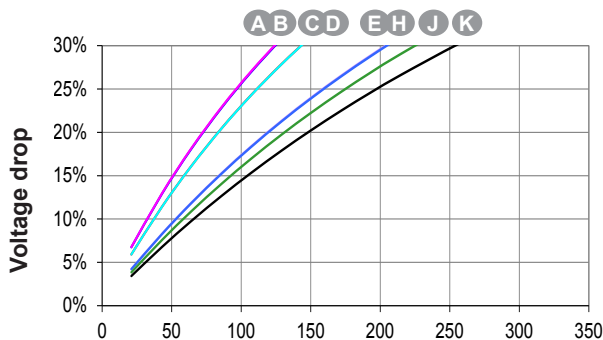

Motor starting (SHUNT)  
Locked rotor kVA at P.F. = 0.6

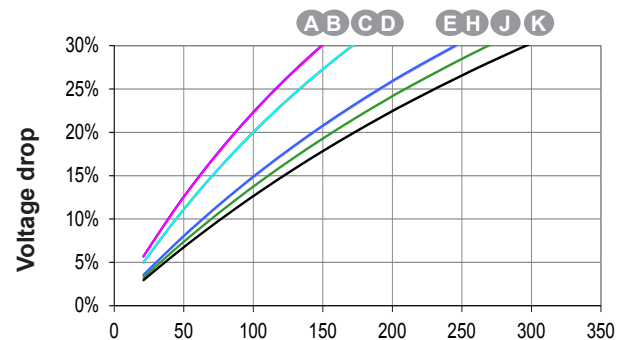

Motor starting (AREP)  
Locked rotor kVA at P.F. = 0.6

- 1) For a starting P.F. other than 0.6, the starting kVA must be multiplied by  $K = \text{Sine P.F.} / 0.8$
- 2) For voltages other than 400V (Y), 230V ( $\Delta$ ) at 50 Hz, then kVA must be multiplied by  $(400/U)^2$  or  $(230/U)^2$ .

## Efficiencies 480 V - 60 Hz (— P.F.: 0.8) (..... P.F.: 1)

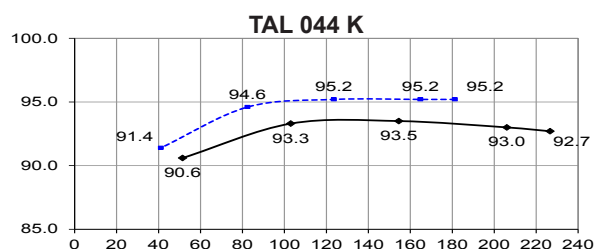
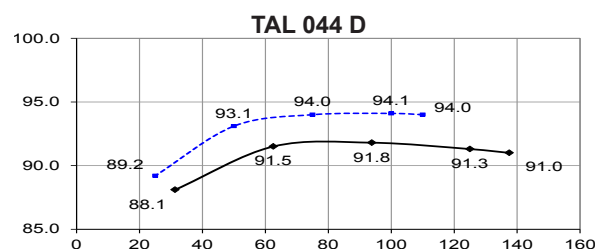
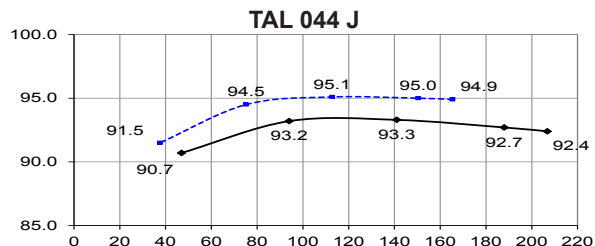
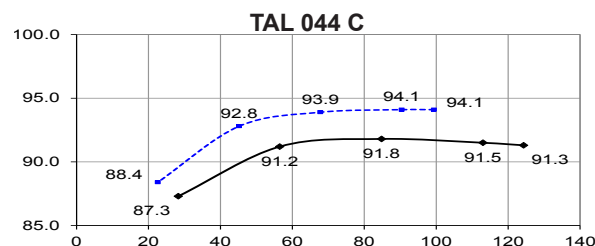
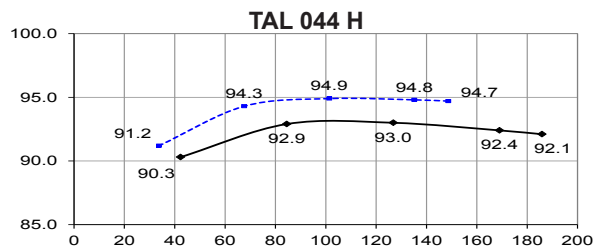
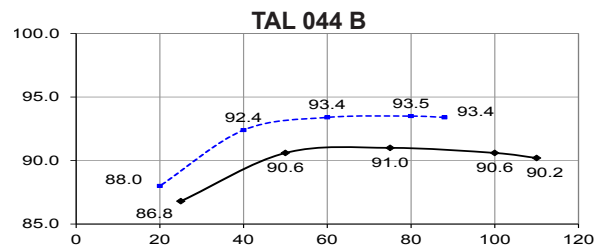
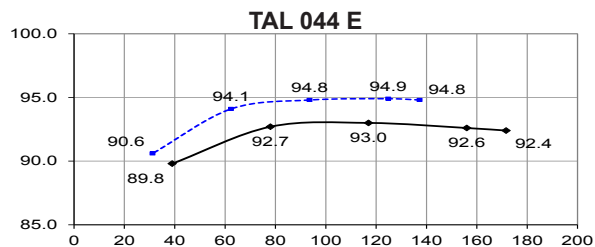
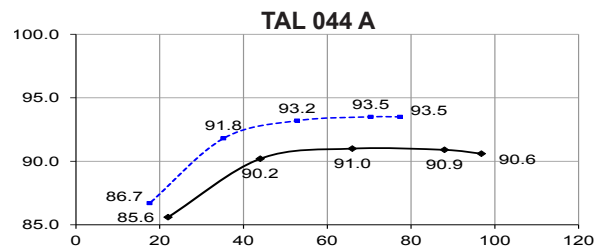

## Reactances (%). Time constants (ms) - Class H / 480 V

	A	B	C	D	E	H	J	K
<b>Kcc</b> Short-circuit ratio	0.55	0.48	0.5	0.46	0.41	0.38	0.38	0.41
<b>Xd</b> Direct-axis synchro. reactance unsaturated	308	350	321	355	348	377	375	356
<b>Xq</b> Quadrature-axis synchro. reactance unsaturated	157	178	164	181	177	192	191	182
<b>T'do</b> No-load transient time constant	2475	2475	2308	2308	2154	2154	2112	2077
<b>X'd</b> Direct-axis transient reactance saturated	12.4	14.1	13.9	15.4	16.1	17.5	17.7	17.1
<b>T'd</b> Short-circuit transient time constant	100	100	100	100	100	100	100	100
<b>X''d</b> Direct-axis subtransient reactance saturated	7.4	8.5	8.3	9.2	9.7	10.5	10.6	10.3
<b>T''d</b> Subtransient time constant	10	10	10	10	10	10	10	10
<b>X''q</b> Quadrature-axis subtransient reactance saturated	16.8	19.1	17.8	19.7	19.6	21.3	21.3	20.3
<b>Xo</b> Zero sequence reactance	0.51	0.59	0.58	0.64	0.67	0.72	0.74	0.71
<b>X2</b> Negative sequence reactance saturated	12.17	13.83	13.1	14.49	14.69	15.91	15.99	15.34
<b>Ta</b> Armature time constant	15	15	15	15	15	15	15	15

## Other class H / 480 V data

	A	B	C	D	E	H	J	K
<b>io (A)</b> No-load excitation current SHUNT and AREP	0.84/1.08	0.84/1.08	0.79/1.02	0.79/1.02	0.67/0.87	0.67/0.87	0.66/0.85	0.68/0.87
<b>ic (A)</b> On-load excitation current SHUNT and AREP	2.6/3.34	2.91/3.76	2.72/3.51	3.01/3.88	2.58/3.32	2.79/3.59	2.79/3.6	2.79/3.59
<b>uc (V)</b> On-load excitation voltage SHUNT and AREP	29.3/23.5	32.6/26.2	30.3/24.4	33.3/26.7	32.4/26	34.8/28	34.7/27.8	34.4/27.6
<b>ms</b> Response time ( $\Delta U = 20\%$ transient)	500	500	500	500	500	500	500	500
<b>kVA</b> Start ( $\Delta U = 20\%$ cont. or $\Delta U = 30\%$ trans.) SHUNT*	149.1	149.5	171.6	171.8	246.2	245.6	269.7	304.1
<b>kVA</b> Start ( $\Delta U = 20\%$ cont. or $\Delta U = 30\%$ trans.) AREP*	178.7	179	205.3	206.5	294.8	295.6	322.4	366.4
<b>%</b> Transient $\Delta U$ (on-load 4/4) SHUNT - P.F.: 0.8 <sub>LAG</sub>	17.7	19.3	19.1	20.4	18.6	19.7	19.9	19.4
<b>%</b> Transient $\Delta U$ (on-load 4/4) AREP - P.F.: 0.8 <sub>LAG</sub>	15.7	17.1	16.9	18.1	16.5	17.4	17.6	17.2
<b>W</b> No-load losses	2868	2868	3156	3156	3387	3387	3611	4040
<b>W</b> Heat dissipation	7047	8289	8303	9490	9876	11039	11750	12269

\* P.F. = 0.6

Transient voltage variation 480V - 60 Hz

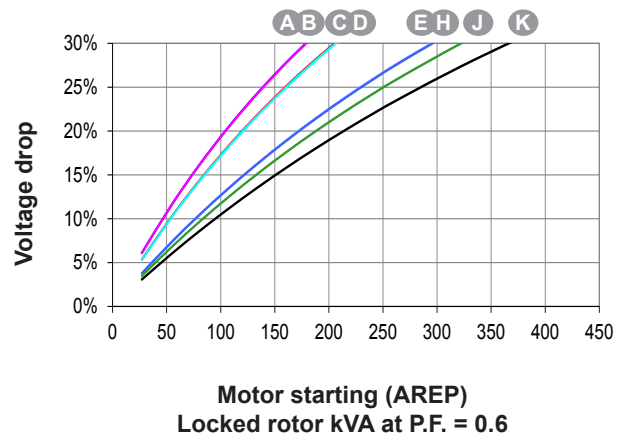
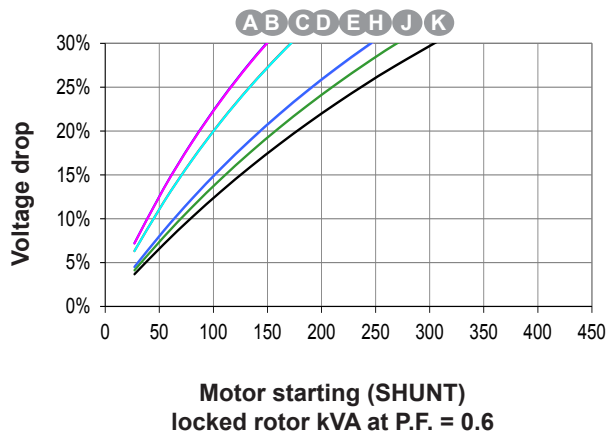
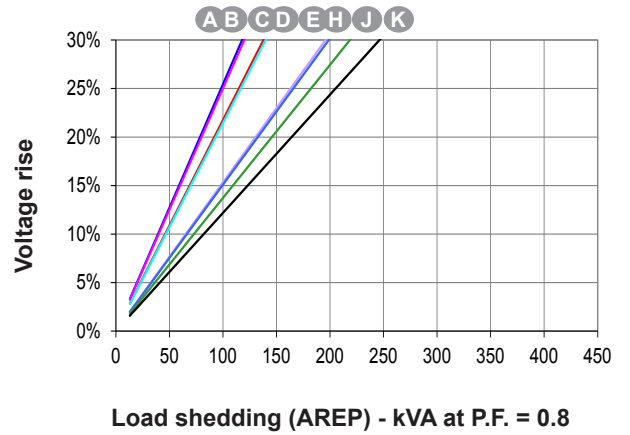
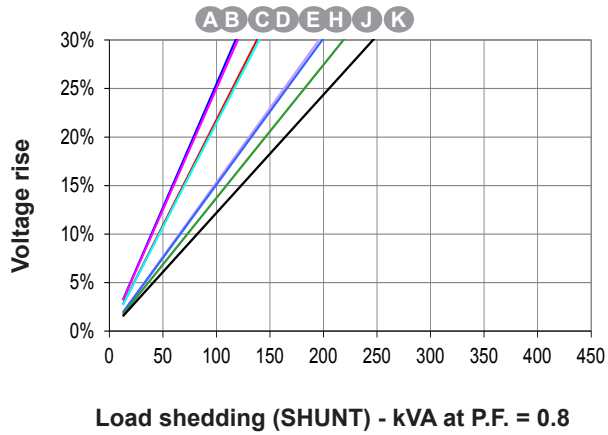
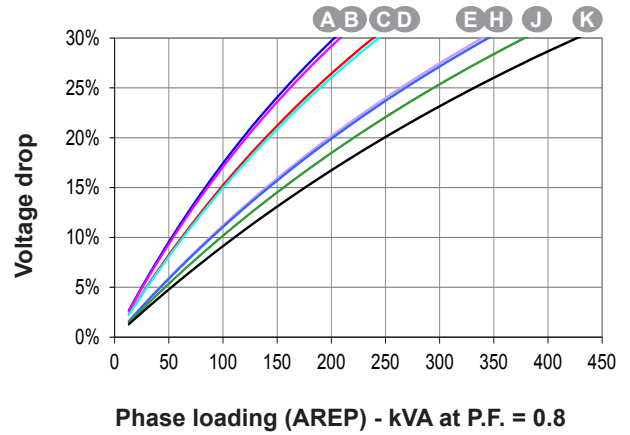
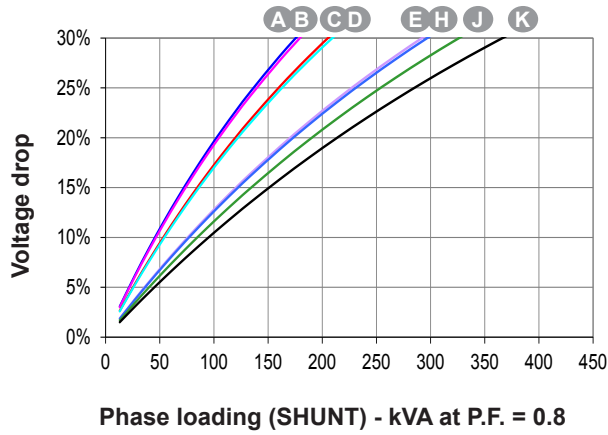

- 1) For a starting P.F. other than 0.6, the starting kVA must be multiplied by  $K = \text{Sine P.F.} / 0.8$
- 2) For voltages other than 480V (Y), 277V ( $\Delta$ ), 240V (YY) at 60 Hz, then kVA must be multiplied by  $(480/U)^2$  or  $(277/U)^2$  or  $(240/U)^2$ .

3-phase short-circuit curves at no load and rated speed (star connection Y)

**TAL 044 A**

Symmetrical —  
Asymmetrical - - -

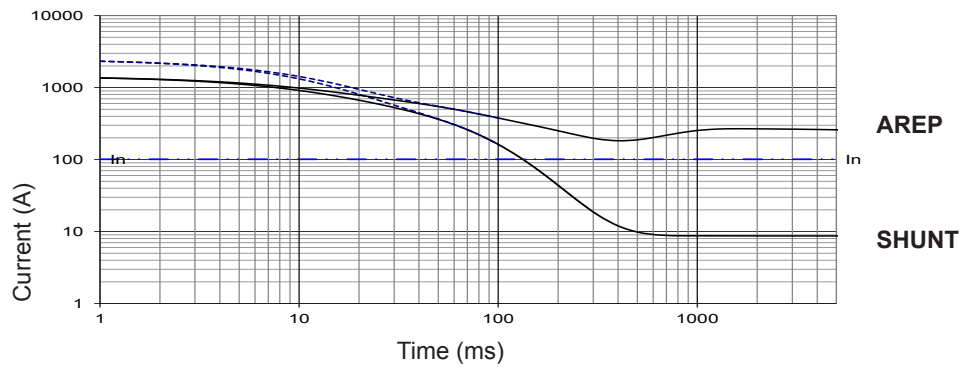

**TAL 044 B**

Symmetrical —  
Asymmetrical - - -

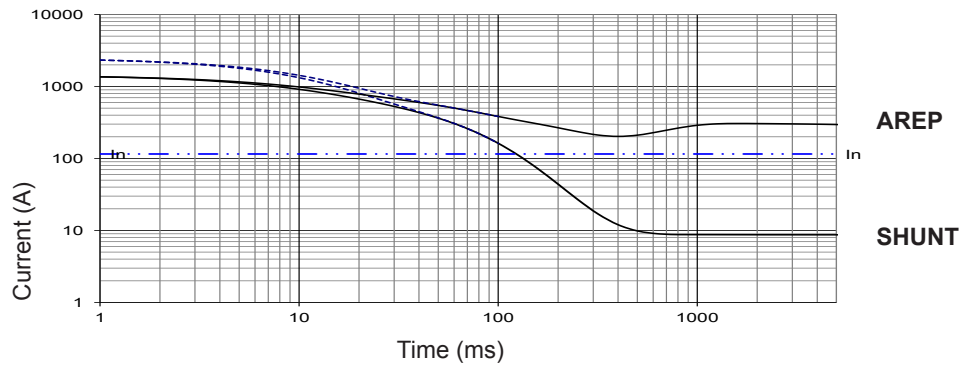

**TAL 044 C**

Symmetrical —  
Asymmetrical - - -

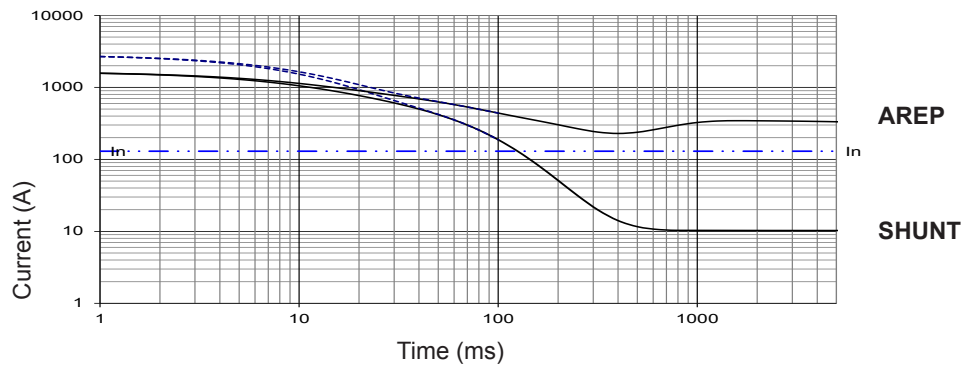

**TAL 044 D**

Symmetrical —  
Asymmetrical - - -

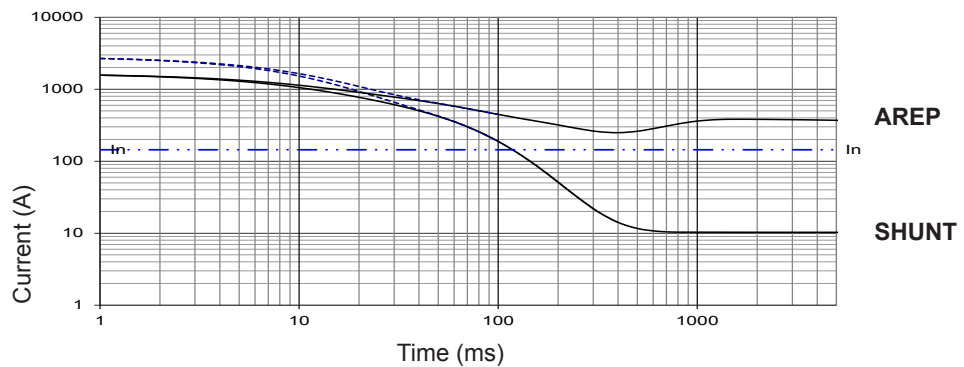

**Influence due to connection**

For (Δ) connection, use the following multiplication factor:  
- Current value x 1.732.

3-phase short-circuit curves at no load and rated speed (star connection Y)

**TAL 044 E**

Symmetrical —  
Asymmetrical - - -

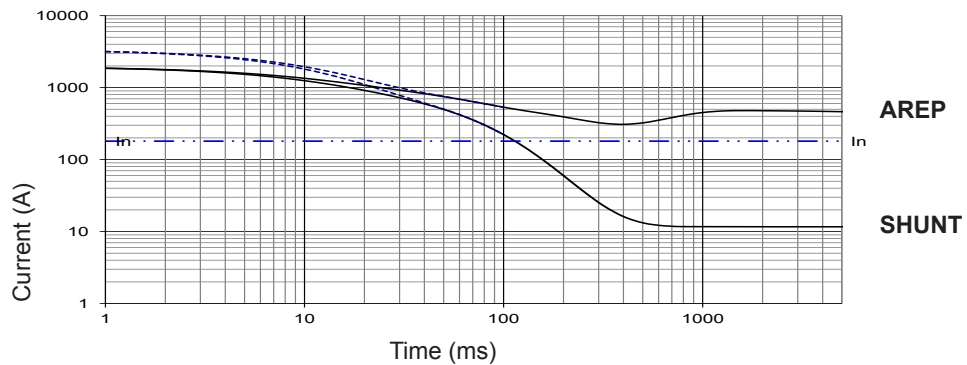

**TAL 044 H**

Symmetrical —  
Asymmetrical - - -

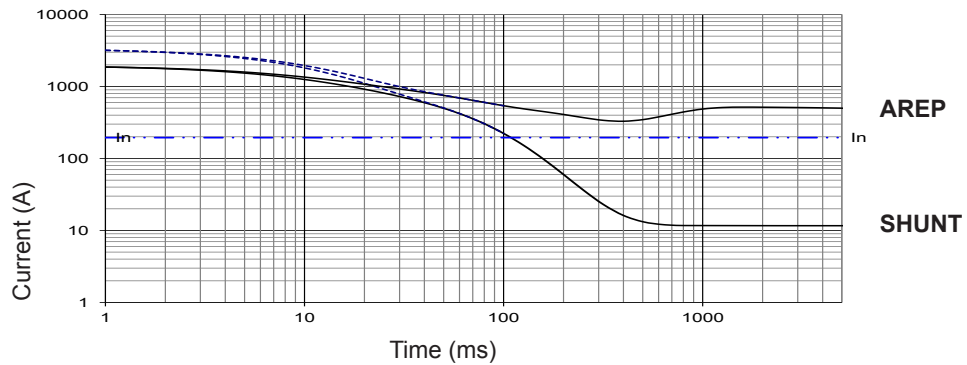

**TAL 044 J**

Symmetrical —  
Asymmetrical - - -

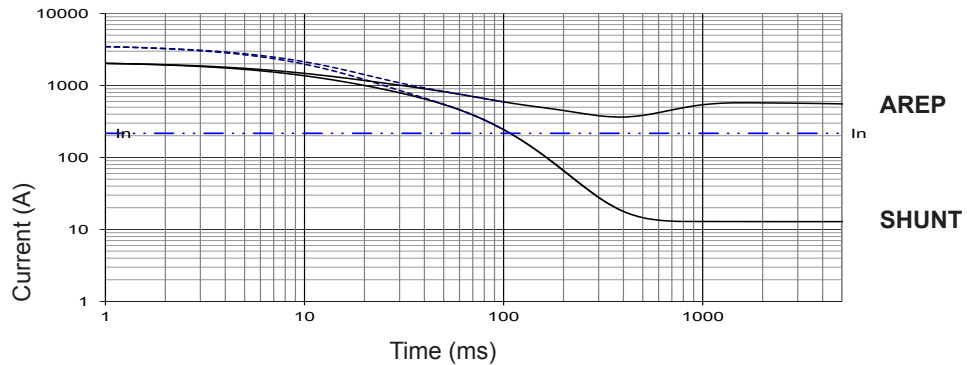

**TAL 044 K**

Symmetrical —  
Asymmetrical - - -

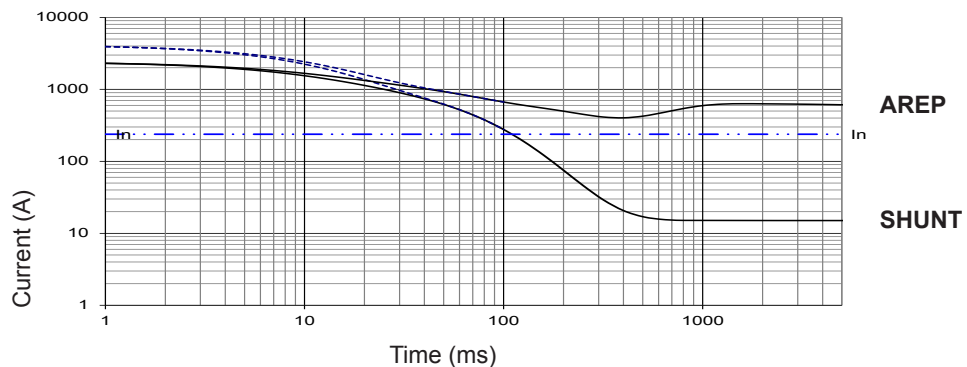

**Influence due to short-circuit**

Curves are based on a three-phase short-circuit.  
For other types of short-circuit,  
use the following multiplication factors.

	3 - phase	2 - phase L / L	1 - phase L / N
Instantaneous (max.)	1	0.87	1.3
Continuous	1	1.5	2.2
Maximum duration		1.5	

# TAL 044 - Dedicated single-phase 57 to 82 kVA - 50 Hz / 80 to 125 kVA - 60 Hz

## General characteristics

Insulation class	H	Excitation system	SHUNT
Winding pitch	2/3 (wind. M 50Hz, M1 60Hz)	AVR type	R121
Number of wires	4	Voltage regulation (*)	± 1 %
Protection	IP 23	Total Harmonic Distortion THD (**) in no-load	< 3.5 %
Altitude	≤ 1000 m	Total Harmonic Distortion THD (**) in linear load	< 5 %
Overspeed	2250 R.P.M.	Waveform: NEMA = TIF (**)	< 100
Air flow (m³/s)	50 Hz: 0.25 - 60 Hz: 0.30	Waveform: I.E.C. = FHT (**)	< 2 %

(\*) Steady state (\*\*) Total harmonic distortion between phases, no-load or on-load (non-distorting)

## Ratings / Efficiencies 50 Hz - 1500 R.P.M. - Winding M

kVA / kW - P.F. = 1(*)							
Duty / T° C	Continuous / 40 °C		Continuous / 40 °C	Stand-by / 40 °C	Stand-by / 27 °C		
Class / T° K	H / 125° K		F / 105° K	H / 150° K	H / 163° K		
Serie (SE)	230 V		η %	230 V	230 V	230V	η %
<b>TAL 044 C</b>	57	91	52	60	63	90.7	
<b>TAL 044 D1</b>	69	91.5	63	73	76	91.1	
<b>TAL 044 E</b>	-	-	-	-	-	-	-
<b>TAL 044 J</b>	82	92.3	75	87	90	92	
<b>TAL 044 K</b>	-	-	-	-	-	-	-

(\*) For P.F. 0.8: derating 15%

## Ratings / Efficiencies 60 Hz - 1800 R.P.M. - Winding M1

kVA / kW - P.F. = 1(*)							
Duty / T° C	Continuous / 40 °C		Continuous / 40 °C	Stand-by / 40 °C	Stand-by / 27 °C		
Class / T° K	H / 125° K		F / 105° K	H / 150° K	H / 163° K		
Serie (SE)	240 V		η %	240 V	240 V	240V	η %
<b>TAL 044 C</b>	80	90	73	85	88	89.7	
<b>TAL 044 D1</b>	100	90	91	106	110	89.7	
<b>TAL 044 E</b>	115	90.7	105	122	127	90.2	
<b>TAL 044 J</b>	-	-	-	-	-	-	-
<b>TAL 044 K</b>	125	91.7	114	133	138	91.4	

(\*) For P.F. 0.8: derating 15%

## Starting motor 230V - 50Hz

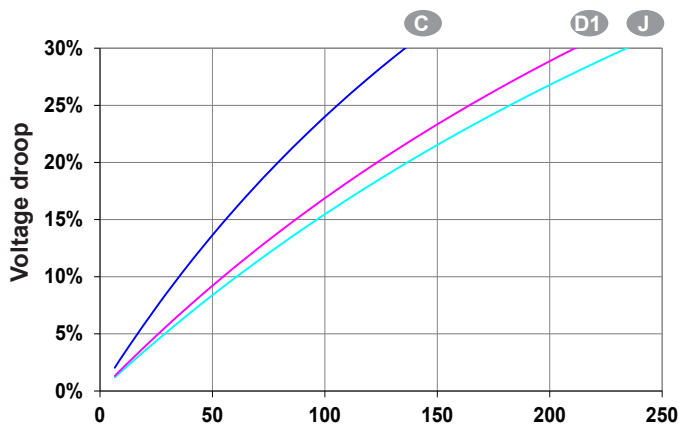

## Starting motor 240V - 60Hz

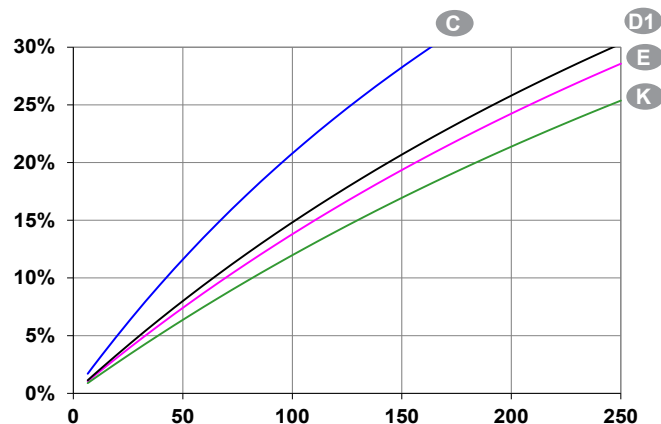

Locked rotor kVA at PF : 0.9



## Single bearing general arrangement

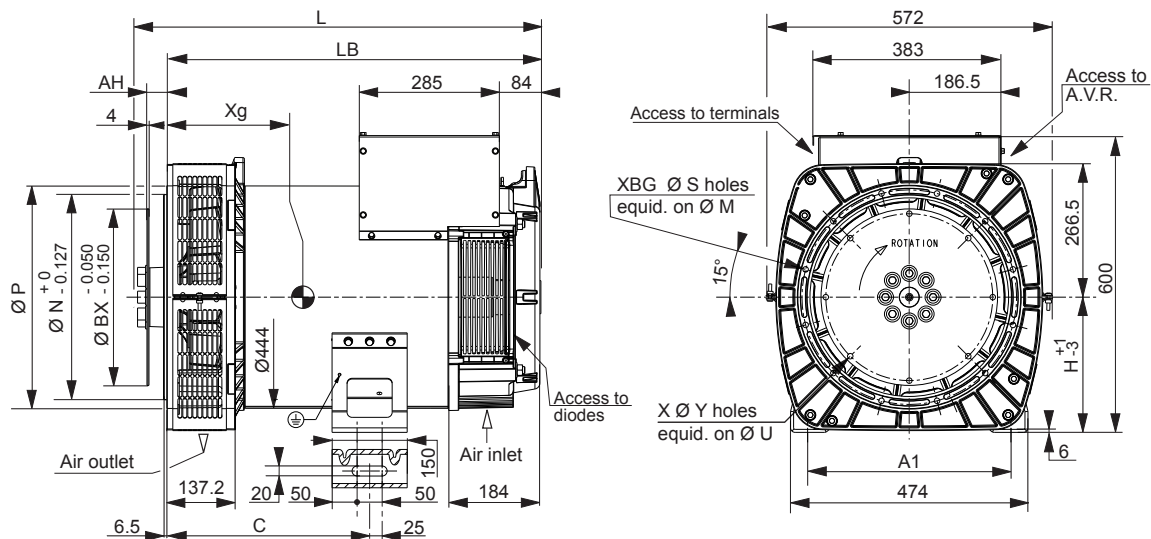

Dimensions (mm) and weight				
Type	L maxi	LB	Xg	Weight/kg
TAL 044 A	750	677	293	262
TAL 044 B	750	677	293	262
TAL 044 C	750	677	313	295
TAL 044 D	750	677	313	295
TAL 044 D1	750	677	313	295
TAL 044 E	820	747	353	368
TAL 044 H	820	747	353	368
TAL 044 J	820	747	365	398
TAL 044 K	860	787	383	433

	Shaft height (mm)		Coupling			
	Standard	Option	Flange	1	2	3
<b>H</b>	270	225	Flex plate			
	Feet length		11 1/2	x	x	x
<b>C</b>	405	332.5	10	x	x	x
<b>A1</b>	406	356				

Flange (mm)					
S.A.E.	P	N	M	S	XBG
3	445	409.58	428.62	11	12
2	485	447.68	466.72	11	12
1	560.5	511.18	530.23	12	10

Flex plate (mm)					
S.A.E.	BX	U	X	Y	AH
11 1/2	352.42	333.38	8	11	39.6
10	314.32	295.28	8	11	53.8

## Torsional data

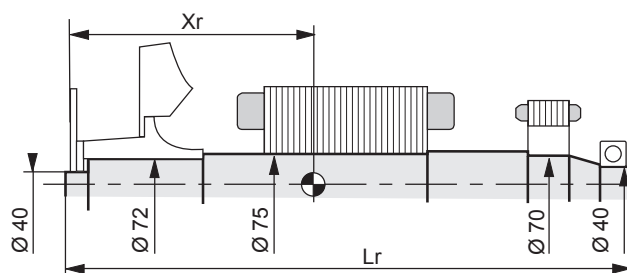

Centre of gravity: Xr (mm), Rotor length: Lr (mm), Weight: M (kg), Moment of inertia: J (kgm <sup>2</sup> ): (4J = MD <sup>2</sup> )								
Flex plate	Flex plate S.A.E. 10				Flex plate S.A.E. 11 1/2			
Type	Xr	Lr	M	J	Xr	Lr	M	J
TAL 044 A	344.7	704	107.2	0.770	332.1	704	106.8	0.769
TAL 044 B	344.7	704	107.2	0.770	332.1	704	106.8	0.769
TAL 044 C	355.2	704	121	0.894	342.4	704	120.6	0.893
TAL 044 D	355.2	704	121	0.894	342.4	704	120.6	0.893
TAL 044 D1	376.1	704	139.1	1.051	363.2	704	138.7	1.050
TAL 044 E	400.2	774	153.7	1.167	387.2	774	153.3	1.166
TAL 044 H	400.2	774	153.7	1.167	387.2	774	153.3	1.166
TAL 044 J	411.0	774	165.5	1.274	398.0	774	165.1	1.273
TAL 044 K	431.0	814	180.6	1.409	417.9	814	180.2	1.408

**NOTE** : Dimensions are for information only and may be subject to modifications. The torsional analysis of the transmission is imperative. All values are available upon request.

**LEROY-SOMER**<sup>™</sup>

[www.leroy-somer.com/epg](http://www.leroy-somer.com/epg)

[Linkedin.com/company/Leroy-Somer](https://www.linkedin.com/company/Leroy-Somer)  
[Twitter.com/Leroy\\_Somer\\_en](https://twitter.com/Leroy_Somer_en)  
[Facebook.com/LeroySomer.Nidec.en](https://www.facebook.com/LeroySomer.Nidec.en)  
[YouTube.com/LeroySomerOfficiel](https://www.youtube.com/LeroySomerOfficiel)



***Nidec***  
**All for dreams**

© Nidec 2018. The information contained in this brochure is for guidance only and does not form part of any contract. The accuracy cannot be guaranteed as Nidec have an ongoing process of development and reserve the right to change the specification of their products without notice.

Moteurs Leroy-Somer SAS. Siège : Bd Marcellin Leroy, CS 10015, 16915 Angoulême Cedex 9, France.  
Capital social : 65 800 512 €, RCS Angoulême 338 567 258.

# InteliLite<sup>NT</sup> AMF 9



## SINGLE SET GEN-SET CONTROLLER

### Description

The InteliLite<sup>NT</sup> AMF 9 is integrated controller for gen-sets operating in single standby mode.

The controller meets all requirements for Auto Mains Failure (AMF) applications including remote communication and internet control, user configuration and complete gen-set monitoring and protection.

InteliLite<sup>NT</sup> AMF 9 is easy to use with a simple intuitive user interface and graphic display. Unit is designed for quick and cost saving commissioning and bring seamless integration with the latest breed of EFI diesel engines from all major manufacturers. This offers a higher level of functionality with users able to display a comprehensive range of values from the EFI engine on standard analog gauges and true RMS measurement of electric values.

### Benefits

- ▶ Less wiring and components
- ▶ Less engineering and programming
- ▶ Cost saving commissioning
- ▶ Remote monitoring reduced call-out costs of service engineers
- ▶ History 100+ records based on running hours
- ▶ Hybrid binary inputs and outputs module – simple way of extension the unit performance
- ▶ SMS on alarm/event
- ▶ Direct communication with EFI engines
- ▶ Perfect price/performance ratio



#### InteliLite<sup>NT</sup> AMF 9 supports J1939 for all major brands:

- |                  |              |           |                          |
|------------------|--------------|-----------|--------------------------|
| • Caterpillar    | • GM         | • MAN     | • Sisu                   |
| • Cummins        | • Isuzu      | • MTU     | • VM Motori              |
| • Detroit Diesel | • Iveco      | • Perkins | • Volvo Penta and others |
| • Deutz          | • John Deere | • Scania  |                          |



ComAp is a member of AMPS (The Association of Manufacturers of Power generating Systems).



ComAp products meet the highest standards, with every stage of production undertaken in accordance with the ISO certification obtained in 1998.

## Features

### 3 phase AMF function

- Over/Under frequency
- Over/Under voltage

### 3 phase generator protections

- Over/Under frequency
- Over/Under voltage
- Over current

### True RMS Voltage measurement

- 3 phase generator voltages:
  - Phase to neutral  
L1 – N, L2 – N, L3 – N
  - Phase to phase  
L1 – L2, L2 – L3, L3 – L1
- 3 phase mains voltages
- Voltage range 277 V p-n, 480 V p-p
- Maximal measured voltage 300 V p-n

### True RMS current measurements

- 3 generator phase currents
- Current range 5 A
- Maximal measured current 10 A
- Ready for generators with  
3 ph 4 wires / 3 ph 3 wires  
/ Split ph / Mono ph

### Event and performance log

- Gen-set text alarm log
- Engine hours history log
- ECU text alarm log
- Test Run scheduler

### Power measurements

- Apparent power per phase
- Total apparent power

### User interface

- Graphic 128 x 64 pixels display
- 2 languages, user changeable from PC
- Setpoints adjustable via controller buttons or PC
- Buttons with mechanical feedback

### Inputs and outputs

- 3 fully configurable analog inputs
- 4 binary inputs; 6 binary outputs
- D+ preexcitation terminal
- Optional 8 hybrid binary inputs/outputs
- Optional 8 analog gauge drive outputs, compatible with VDO, Datcon gauges

### EFI engine support

- Cummins Modbus
- Engine specific J1939 for all major manufacturers (see table on page 1)
- Diagnostic messages in plain text

### Engine protections

- Oil pressure protection
- Coolant temperature
- Fuel level

### Active calls

- 1 channel
- SMS alarm
- Event SMS

### Miscellaneous features

- Operation mode  
– AMF/MRS application switch
- Maintenance – service time counter
- Engine hours counter

### Communication interfaces

- Optional RS232, RS485 (including Modem support) or USB plug-in interface
- Optional GSM modem via IL-NT GPRS

### Mechanical

#### and operation parameters

- Unit dimension 120 x 180 mm
- Sealed front face rated for IP65
- Hard plexiglass LCD cover
- Operation temperature:
  - -20 °C to +70 °C standard version
  - -40 °C to +70 °C low temperature ver.
- Power supply voltage 8–36 V
- Voltage drops shorter than 50 ms do not affect operation

ANSI code	Protection
59	Overvoltage
27	Undervoltage
81H	Overfrequency
81L	Underfrequency
50+51	Overcurrent*
47	Phase rotation**
71	Gas (Fuel) level

\* Shortcurrent only / \*\* Fixed setting

## Schematic diagram

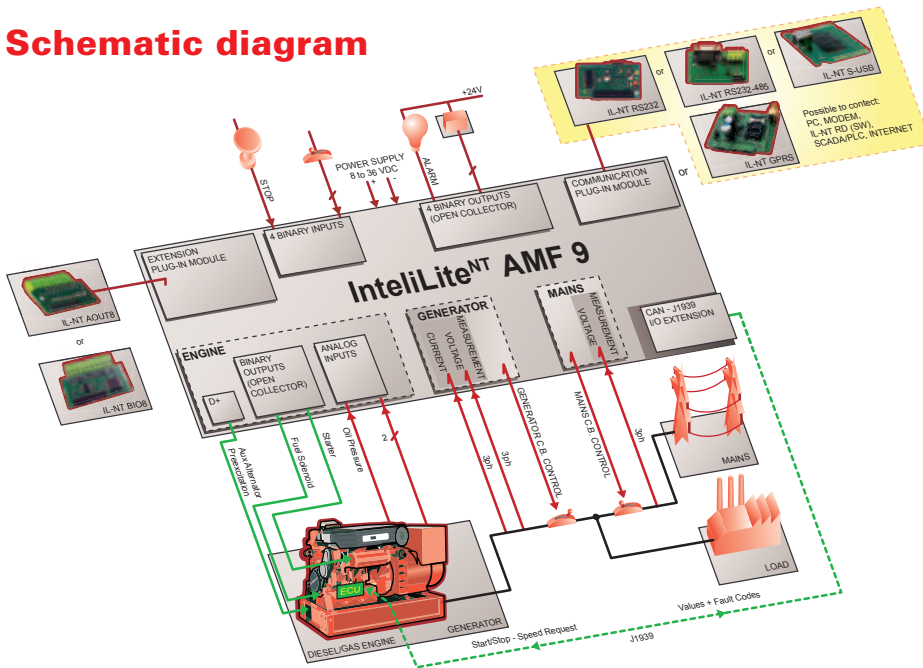

## Accessories and PC tools

- ▷ **IL-NT AOUT8** – Analog Outputs for PWM Gauges Module
- ▷ **IL-NT BIO8** – Binary Input/Output (PWM) Module
- ▷ **IL-NT RD (SW)** – Remote Display Software for IntelLite<sup>NT</sup> Controllers
- ▷ **IG-IB** – InternetBridge support
- ▷ **IL-NT GPRS** – GSM Modem/Wireless Internet Module
- ▷ **IL-NT RS232** – RS232 Extension Board
- ▷ **IL-NT RS232-485** – Dual Port Extension Board
- ▷ **IL-NT S-USB** – Service USB Module
- ▷ **InteliMonitor** – PC Monitoring Tool
- ▷ **WinScope** – Special Graphical Controllers' Monitoring Software
- ▷ **LiteEdit** – PC Configuration and Monitoring Tool



MANUFACTURER:

**ComAp, spol. s r.o.**

Czech Republic

Phone: + 420 246 012 111

Fax: + 420 266 316 647

E-mail: [info@comap.cz](mailto:info@comap.cz)

Internet: [www.comap.cz](http://www.comap.cz)

LOCAL DISTRIBUTOR / PARTNER:

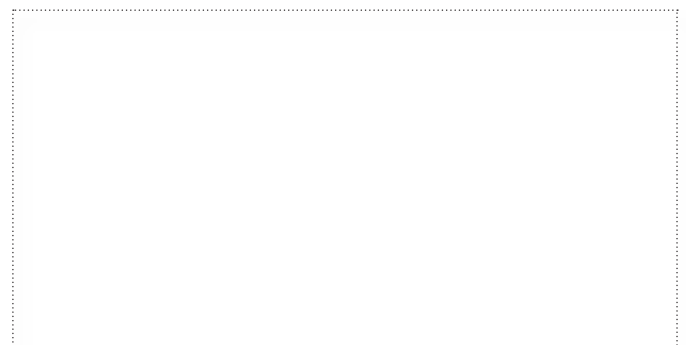

**Customer satisfaction is our mission. We continuously develop the best people to succeed in our mission.**